

---

Theses and Dissertations

---

Fall 2010

## Detecting distraction and degraded driver performance with visual behavior metrics

Lora Yekhshatyan  
*University of Iowa*

Follow this and additional works at: <https://ir.uiowa.edu/etd>

 Part of the [Industrial Engineering Commons](#)

Copyright 2010 Lora Yekhshatyan

This dissertation is available at Iowa Research Online: <https://ir.uiowa.edu/etd/910>

---

### Recommended Citation

Yekhshatyan, Lora. "Detecting distraction and degraded driver performance with visual behavior metrics." PhD (Doctor of Philosophy) thesis, University of Iowa, 2010.  
<https://doi.org/10.17077/etd.wby403n1>

---

Follow this and additional works at: <https://ir.uiowa.edu/etd>

 Part of the [Industrial Engineering Commons](#)

DETECTING DISTRACTION AND DEGRADED DRIVER  
PERFORMANCE WITH VISUAL BEHAVIOR METRICS

by

Lora Yekhshatyan

An Abstract

Of a thesis submitted in partial fulfillment of the requirements  
for the Doctor of Philosophy degree in  
Industrial Engineering in the  
Graduate College of  
The University of Iowa

December 2010

Thesis Supervisor: Professor John D. Lee

## ABSTRACT

Driver distraction contributes to approximately 43% of motor-vehicle crashes and 27% of near-crashes. Rapidly developing in-vehicle technology and electronic devices place additional demands on drivers, which might lead to distraction and diminished capacity to perform driving tasks. This situation threatens safe driving. Technology that can detect and mitigate distraction by alerting drivers could play a central role in maintaining safety. Correctly identifying driver distraction in real time is a critical challenge in developing distraction mitigation systems, and this function has not been well developed. Moreover, the greatest benefit may be from real-time distraction detection in advance of dangerous breakdowns in driver performance.

Based on driver performance, two types of distraction – visual and cognitive – are identified. These types of distraction have very different effects on visual behavior and driving performance; therefore, they require different algorithms for detection. Distraction detection algorithms typically rely on either eye measures or driver performance measures because the effect of distraction on the coordination of measures has not been established. Combining both eye glance and vehicle data could enhance the ability of algorithms to detect and differentiate visual and cognitive distraction.

The goal of this research is to examine whether poor coordination between visual behavior and vehicle control can identify diminished attention to driving in advance of breakdowns in lane keeping. The primary hypothesis of this dissertation is that detection of changes in eye-steering relationship caused by distraction could provide a prospective indication of vehicle state changes. Three specific aims are pursued to test this hypothesis. The first aim examines the effect of distracting activity on eye and steering movements to assess the degree to which the correlation parameters are indicative of distraction. The second aim applies a control-theoretic system identification approach to the eye movement and steering data to distinguish between distracted and non-distracted conditions. The third aim examines whether changes of eye-steering coordination

associated with distraction provide a prospective indication of breakdowns in driver performance, i.e., lane departures.

Together, the three aims show how that a combination of visual and steering behavior, i.e., eye-steering model, can differentiate between non-distracted and distracted state. This model revealed sensitivity to distraction associated with off-road glances. The models derived for different drivers have similar structure and fit to data from other drivers reasonably well. In addition, the differences in model order and model coefficients indicate the variability in driving behavior: some people generate more complex behavior than others. As was expected, eye-steering correlation on straight roads is not as strong as observed on curvy roads. However, eye-steering correlation measured through correlation coefficient and time delay between two movements is sensitive to different types of distraction. Time delay mediates changes in lane position and the eye-steering system predicts breakdowns in lane keeping. This dissertation contributes to developing a distraction detection system that integrates visual and steering behavior. More broadly, these results suggest that integrating eye and steering data can be helpful in detecting and mitigating impairments beyond distraction, such as those associated with alcohol, fatigue, and aging.

Abstract Approved:

---

Thesis Supervisor

---

Title and Department

---

Date

DETECTING DISTRACTION AND DEGRADED DRIVER  
PERFORMANCE WITH VISUAL BEHAVIOR METRICS

by

Lora Yekhshatyan

A thesis submitted in partial fulfillment  
of the requirements for the Doctor of  
Philosophy degree in Industrial Engineering  
in the Graduate College of  
The University of Iowa

December 2010

Thesis Supervisor: Professor John D. Lee

Copyright by  
LORA YEKHSHATYAN  
2010  
All Rights Reserved

Graduate College  
The University of Iowa  
Iowa City, Iowa

CERTIFICATE OF APPROVAL

---

PH.D. THESIS

---

This is to certify that the Ph.D. thesis of

Lora Yekhshatyan

has been approved by the Examining Committee  
for the thesis requirement for the Doctor of Philosophy  
degree in Industrial Engineering at the December 2010 graduation.

Thesis Committee:

---

John D. Lee, Thesis Supervisor

---

Andrew Kusiak

---

Geb W. Thomas

---

Yong Chen

---

Shaun P. Vecera

To my husband and children



## ACKNOWLEDGMENTS

I would like to thank John D. Lee, my advisor, for his continued support, wisdom, and patience. I appreciate his assistance, motivation, and encouragement that help me to make this accomplishment. Very special thanks are to Yulan Liang who provided data for my study as well as to Michelle Reyes and all the members of cognitive systems laboratory (CSL) who supported me. I am also grateful to Richard and Sue Simon, friends of mine, and my family for inspiration and love.

## CONTENTS

LIST OF TABLES .....	vi
LIST OF FIGURES .....	vii
CHAPTER 1. INTRODUCTION .....	1
Research objectives and specific aims .....	5
Expected contributions .....	7
CHAPTER 2. BACKGROUND AND LITERATURE REVIEW .....	9
Driver distraction .....	9
Distraction sources and drivers' involvement .....	9
Types and consequences of distraction .....	12
Distraction detection, mitigation, and prevention .....	14
Distraction detection .....	14
Indicators of driver distraction .....	14
Distraction detection algorithms .....	17
Distraction mitigation and prevention .....	19
Current distraction detection systems .....	21
Perception and action in driving .....	24
Intermittent control .....	26
Eye-steering coordination .....	28
Driver control modeling through visual information .....	31
Models based on time series and system identification approaches .....	34
ARIMA model .....	37
ARX and ARMAX models .....	38
Process stationarity .....	39
Driver state assessment through system identification .....	42
Gaps in literature and proposed work .....	43
CHAPTER 3. MEASURE OF CHANGES IN EYE AND STEERING MOVEMENTS CAUSED BY DISTRACTION .....	48
Analysis method .....	48
Interrupted time series analysis .....	48
Correlation analysis .....	51
Eye-steering correlation for eye movement types .....	53
Data collection and processing .....	56
Experimental data .....	56
Data pre-treatment .....	58
Glance classification .....	61
Signal length and sampling .....	64
Results and discussion .....	66
Interrupted eye and steering time series analysis .....	67
Correlation analysis of eye and steering movements .....	70
Conclusion .....	78
CHAPTER 4. DRIVER STATE ASSESSMENT THROUGH THE SYSTEM IDENTIFICATION APPROACH .....	83

Analysis method .....	83
System identification .....	84
Model estimation .....	85
Model validation .....	86
Driver state differentiation through eye-steering system modeling .....	88
Eye-steering model estimation .....	92
Eye-steering model validation .....	94
Results and discussion .....	100
Conclusion .....	114
CHAPTER 5. ESTIMATION OF THE INDIRECT EFFECT OF DISTRACTION ON VEHICLE STATE .....	118
Analysis method .....	118
Results and discussion .....	122
Lane departures .....	124
Conclusion .....	130
CHAPTER 6. CONCLUSIONS .....	133
REFERENCES .....	138

## LIST OF TABLES

Table 1. Summary table of drivers' engagement in secondary task and its influence on crash/near crash likelihood .....	11
Table 2. Summary of distraction assessment through visual and driver performance metrics.....	16
Table 3. Distraction detection systems .....	23
Table 4. Summary of models' structure.....	36
Table 5. Combination of different types of glances to define an eye movement typical for different types of distraction.....	64
Table 6. Fundamental frequencies and cycle length for eye and steering movement signals .....	66
Table 7. Summary of interrupted time series analysis for horizontal eye position.....	70
Table 8. Statistical results of the autocorrelation coefficient and time delay (in seconds) pair-wise comparison.....	75
Table 9. Statistical results of the pair-wise comparisons.....	77
Table 10. Summary of the models' estimation and validation characteristics .....	98
Table 11. Eye-steering system models for distracted and non-distracted driving .....	99
Table 12. Summary of the chosen models. The model structure is defined through number of previous inputs $n_b$ , previous outputs $n_a$ , and delayed inputs $n_k$ . Standard deviations of the coefficients are in curly brackets for $a_1$ - $a_{n_a}$ and $b_{n_k}$ .....	108
Table 13. Regression models analysis summary .....	124

## LIST OF FIGURES

Figure 1. Chronological interrelation between driver state, vehicle control, and vehicle state: changes in visual behavior could cause changes in vehicle control that, in turn, affect vehicle state.....	5
Figure 2. Relations of the schema, gaze, visual, and motor systems during the performance of a visually controlled action (Land, 2009).....	25
Figure 3. General linear model structure .....	35
Figure 4. Eye movement – steering – lane position relationship.....	45
Figure 5. Comparison of the different timelines for distraction indication. Time of event is associated with the time of maximum risk of crash caused by distraction.....	47
Figure 6. The effect of intervention (e.g., distraction) on time series: changes in a level and in a trend.....	50
Figure 7. Autocorrelation functions for random and periodic signals.....	52
Figure 8. Cross-correlogram with one peak calculated for two signals with the cross correlation showing a strong association between them: one signal is lagged relative to the other one by 4 sec (time delay) .....	53
Figure 9. Glance locations and hypothetical scatter plots of associated horizontal eye position and steering wheel angle for non-distracted and distracted driving on a straight road .....	55
Figure 10. In-vehicle display of the visual-manual arrow matching task (Liang, 2009).....	57
Figure 11. Horizontal eye position before and after outliers' identification and segments' interpolation. Sharp spikes are associated with outliers .....	59
Figure 12. Examples of glance locations before and after exclusion of outliers .....	60
Figure 13. Data preprocessing flow chart.....	61
Figure 14. Classification of glances.....	63
Figure 15. Interrupted time series analysis of steering angle (left) and horizontal eye position (right): the time series fitted with polynomial function.....	68
Figure 16. Calculated (a) level and (b) slope mean values (with standard deviation bar) for horizontal eye position time series.....	69
Figure 17. An example of autocorrelation and cross-correlation functions for detrended steering angle and horizontal eye position for no-distraction and distracted conditions. The functions were calculated for all the 30-second segments from Subject 4 driving session. The dashed lines are 95% confidence intervals.....	73

Figure 18. Autocorrelation coefficient and time lag changes with distracted condition .....	74
Figure 19. Cross-correlation analysis statistics: mean values with standard error bar for correlation coefficient and time delay (in seconds) .....	77
Figure 20. Distribution of (a) steering angle and (b) horizontal eye position for non-distracted (dark bars) and visually distracted (white bars) conditions.....	89
Figure 21. Detrended (a) steering angle and (b) horizontal eye position spectra for non-distracted (black line) and distracted (red line) conditions.....	91
Figure 22. Auto- and cross- correlation functions calculated for eye and steering signals for 10-second segments of non-distracted (blue line) and distracted (red line) conditions.....	92
Figure 23. Steering angle and horizontal eye position (60-second sample of non-distracted driving).....	93
Figure 24. Comparison of candidate models for baseline driving: a) simulated and measured output comparison with Best Fit values; b) auto- and cross-correlation for residuals (the horizontal scale is the number of lags (samples) between the signals at which the correlation is estimated); and c) measured minus simulated output (error).....	95
Figure 25. Comparison of SISO (one-input) and MISO (two-input) models.....	96
Figure 26. Comparison of candidate models for distracted driving (with visual task): a) simulated and measured output comparison with <i>Best Fit</i> values; b) auto- and cross- correlation for residuals (the horizontal scale is the number of lags (samples) between the signals at which the correlation is estimated); and c) measured minus simulated output (error).....	97
Figure 27. Schema of model development and driver state identification through model performance for a single driver (step 1). Step 2, when the data of non-distracted and distracted driving from all the drivers are applied to each model, is not shown on the schema .....	101
Figure 28. Slope statistics: mean values (with standard deviation bar) for non-distracted and distracted driving.....	103
Figure 29. Trend information for 30-second segments of driving with visual task: a) negative slope; b) zero slope; c) positive slope .....	104
Figure 30. Comparison of a raw and filtered eye movement signal.....	104
Figure 31. Comparison of candidate models for non-distracted driving of Subject 1: a) 30 steps ahead predicted and measured output comparison; b) auto- and cross- correlation for residuals (the horizontal scale is the number of lags (samples) between the signals at which the correlation is estimated); and c) residuals (error).....	106

Figure 32. Model parameters variation histogram and confidence intervals across the subjects.....	107
Figure 33. Model performance for (a) types of eye movement of baseline condition and (b) distracted conditions.....	111
Figure 34. <i>Best Fit</i> values (with standard deviation bar) for non-distracted and distracted conditions .....	111
Figure 35. Measured and 30 steps ahead predicted by the model m4 output for (a) baseline condition and (b) visually distracted condition. Negative value of <i>Best Fit</i> indicates that estimation algorithm failed to converge .....	112
Figure 36. Distributions of the Best Fit for non-distracted, visually distracted, and cognitively distracted conditions and cut-off points. The probability density functions (pdf) for cognitive condition almost coincide with the pdf for baseline condition and is not shown on the graph .....	113
Figure 37. ROC curves. Cut-off points are defined as 15, 25, 50 and 75-percentiles of the <i>Best Fit</i> values (baseline condition).....	114
Figure 38. Models' comparison on their ability to detect distraction: triangles – for visual distraction and stars – for cognitive/visual distraction.....	114
Figure 39. Model with moderator effect.....	121
Figure 40. Model with mediator effect .....	121
Figure 41. Three groups of segments with and without lane departures .....	126
Figure 42. The residuals (predicted minus measured output) for two groups of segments with (red line) and without (black dotted line) lane departures .....	129
Figure 43. Cumulative sum of residuals for two groups of segments with (red line) and without (black dotted line) lane departures (left graph) and fitted with linear regression cumulative sum of residuals (right graph). For any value x on the horizontal axis on the left graph, the corresponding value on the vertical axis is the sum of the residuals associated with the values less than or equal to x.....	129

## CHAPTER 1. INTRODUCTION

According to the Fatality Analysis Reporting System (FARS, 2008) of National Highway Traffic Safety Administration (NHTSA), the fatality rate per 100 million vehicle miles decreased by 17 percent from 2000 to 2008 (1.53 and 1.27 respectively). These statistics suggest that driving is becoming safer, likely reflecting a combination of changes in driver behavior as well as road and vehicle design (SafetyNet, 2009). In-vehicle information systems (IVIS) and advanced driver assistance systems (ADAS) are intended to enhance safety and mobility, and the reduction in fatalities partially reflects these advances.

However, rapid development of in-vehicle technology and electronic devices threatens to undermine such improvements. These systems could place demands on drivers that might lead to distraction and a diminished capacity to perform driving tasks (Hoedemaeker and Neerinx, 2007). Fatal crashes with reported driver distraction increased from 10 percent to 16 percent during the period from 2005 to 2009 (NHTSA, 2010). Moreover, driving is becoming more demanding due to increasing traffic density: the number of licensed drivers in the US increased from 190.6 million in 2000 to 208.3 million in 2008 (FARS, 2008). These trends suggest that driver distraction detection and mitigation could help maintain safety by alerting inattentive drivers to demanding driving situations.

Driving is a complex and demanding task, but drivers often shift their attention between driving and non-driving tasks (Young and Regan, 2007). Such intermittent attention to the road can undermine driving safety, but drivers often adapt their behavior to the environment by making decisions as to when to perform the secondary task without compromising driving performance (Poysti, Rajalin et al., 2005). To complete the secondary task successfully and to maintain safe driving, drivers often compensate for decreased attention to driving by increasing their safety envelope, i.e., reducing speed and



maintaining larger headways (Horberry, Anderson et al., 2006). However, this compensatory strategy is not always successful. Drivers fail to fully compensate for their inattention to driving because they often underestimate the risks involved in performing particular secondary tasks (Strayer and Johnston, 2001; Lesch and Hancock, 2004; Horrey, Lesch et al., 2008). In these cases, drivers fail to divide their attention between driving and secondary tasks adequately. This excessive or poorly timed diversion of attention from driving can undermine driving performance and increase the crash risk.

The contribution of such poorly timed diversions of attention make substantial contributions to crashes. An analysis of the naturalistic driving data from 100 instrumented vehicles (100-car study) found that driver inattention contributed to 78% of crashes and 65% of near-crashes (Klauer, Dingus et al., 2006). In this study, driver inattention included “secondary task engagement,” “driving related inattention to the forward roadway,” “non-specific eye glance away from the forward roadway,” and “drowsiness.” Distraction caused by secondary tasks associated with off-road glances was the most frequent type of inattention observed in this study. It contributed to approximately 43% of crashes and 27% of near-crashes, implying that the risk of crash while performing secondary tasks is higher than the risk while driving without any secondary tasks.

The type of distraction affected the likelihood of crashing. Complex secondary tasks, such as dialing a cell phone or reading, increased the likelihood of crashes/near-crashes by three times, producing an odds ratio (OR) of 3.10 (confidence interval (CI): 1.72, 5.47). Moderately complex tasks, such as inserting/retrieving CDs or eating, increased the crash likelihood by 2.1 (CI: 1.62, 2.72). Klauer, Dingus et al, (2006) defined task complexity as the number of glances away from the road and the number of button presses: the bigger these numbers the more complex the task. In general, glances totaling more than two seconds for any purpose increased near-crash/crash risk to double

that of normal baseline driving. This result indicates that safe driving can be directly related to a driver glance pattern – the combination of off-road and on-road glances.

Secondary task performance changes in drivers' glance patterns even when the task does not require the driver to look away from the road (Harbluk, Noy et al., 2007). Gaze concentration, i.e., percent road centre (PRC), was found to be highly sensitive to the demands of visual and cognitive in-vehicle tasks. Gaze concentration decreases with visual task difficulty and increases with cognitive task difficulty (Victor, Harbluk et al., 2005). Moreover, the changes in a driver glance pattern can identify the intention to engage in non-driving activities: eye movements in advance of attention shifts are motivated by the action preparation and preliminary perception of objects and events (Land, 2006).

Based on the effect of the secondary task on driver performance, two types of distraction – visual and cognitive – were distinguished (Victor, 2005). Visual distraction associated with glances away from the road leads to lapses in vehicle control. Cognitive distraction associated with allocation of glances to the road center leads to the more precise vehicle control but diminishes driver's perception of the broader driving situation. Both cognitive and visual distractions are revealed through eye movements.

Technology that can detect and mitigate distraction could play a central role in maintaining safety. A system that can monitor and continuously evaluate distraction to warn drivers or even to take over vehicle control could help drivers better assess the situation and improve driving performance. Real-time distraction assessment can help drivers redirect attention back to the driving task when the system detects distraction according to predetermined criteria. Concurrent feedback to guide immediate improvement or retrospective feedback after the trip to induce long-term behavioral changes helped drivers modulate distracting activities (Donmez, Boyle et al., 2007; Donmez, Boyle et al., 2008). The greatest benefit may be from real-time detection of diminished driver performance in advance of dangerous situations caused by inattention.

Correctly identifying driver distraction in real time is a critical challenge in developing these distraction mitigation systems, and this function has not been well developed. The difference in visual behavior and driving performance associated with different types of distraction requires different sets of sensors and algorithms to detect distraction (Liang, 2009). The algorithms for distraction detection are mostly based either on eye measures or on driver performance measures (e.g., speed, lane position, and steering); the relationship between these two types of measures is not established. The combination of different approaches, e.g., coupling the distraction detection algorithms based on different sources such as eye glance and vehicle data, could increase sensitivity of the system and safety benefit framework to detect different types of distraction. Figure 1 shows the relationship between visual behavior, vehicle control, vehicle state, and crash risk: distraction causes changes in glance patterns that lead to breakdowns in vehicle control and, as a result, can undermine safety.

This research will examine whether poor coordination between visual behavior and vehicle control can identify diminished attention to driving and predict breakdowns in lane keeping. It is hypothesized that there are time lags between (1) visual behavior and vehicle control associated with oculomotor control and (2) vehicle control and vehicle state caused by vehicle dynamics. The relationship between eye position and steering angle (eye-steering correlation) measured through correlation coefficient and time delay is expected to be sensitive to distraction. Thus, detection of changes in eye-steering relationship caused by distraction could provide a prospective indication of dangerous changes in vehicle state, such as lane departures.

This research investigates the changes in correlation between visual and steering behaviors while a driver is involved in a secondary task compared to when a driver is not. The degree of correlation will be defined by the strength of relationship between eye movements and steering wheel movements and the time delay between them. Changes in correlation are expected to precede lane departures, providing a useful measure of

distraction. This examination of coordination will also produce a deeper understanding of how distractions influence driving. Such an understanding will support design of distraction detection systems (Figure 1).

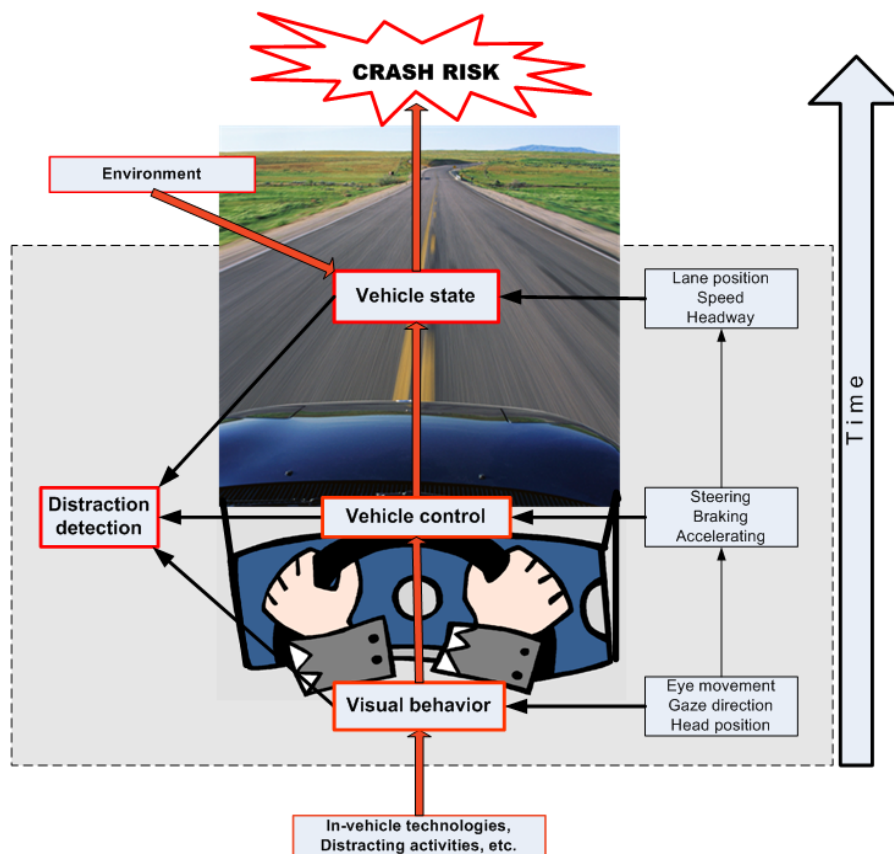

Figure 1. Chronological interrelation between driver state, vehicle control, and vehicle state: changes in visual behavior could cause changes in vehicle control that, in turn, affect vehicle state

### Research objectives and specific aims

The long-term goal of this research is to develop control-theoretic techniques to identify driver impairment by combining eye movement and driver performance metrics. In the context of distraction-related impairment, this objective is achieved through the following aims:

Aim 1: Examine the effect of distraction on eye movements (i.e., horizontal eye position) and vehicle control (i.e., steering angle) and assess the degree to which the correlation parameters – coefficient and time delay between these variables – are indicative of distraction. An interrupted time series analysis and a correlation analysis are performed. The interrupted time series analysis evaluates changes in the steering angle and horizontal eye position time series as a response to the intervention of a non-driving activity (e.g., visual, cognitive, and cognitive/visual distraction). The correlation analysis assesses the relationship between these two time series and the changes caused by performing secondary tasks, i.e., distraction.

Aim 2: Distinguish between distracted and non-distracted driving using a control-theoretic approach of eye-steering system identification. This approach defines a mathematical model of eye-steering system based on measured input-output data from baseline (non-distracted) condition. Using data from distracted condition as an input, the model performance should change to indicate distraction. The correlation statistics defined in Aim 1 support the model development: the choice of a model structure and timing between input and output are sustained by auto-correlation and cross-correlation analyses results. The evaluated cross-correlation between signals supports prediction of steering wheel position through eye movements; and the presence of autocorrelation in steering signal supports prediction of a current steering wheel position through its previous values. Time delay between eye and steering signals defines relative timing between input and output.

Aim 3: Examine whether predicted distracted condition provides a prospective indication of breakdowns in driver performance (lane departures). The eye–steering correlation coefficient is examined to assess whether it acts as a moderator or a mediator. A moderator affects the direction and strength of the relationship between an independent variable and a dependent variable; a mediator explains this relationship. A moderator specifies when certain effect will hold; a mediator specifies how or why such an effect

occurs. If the eye–steering correlation coefficient emerges as a moderator, then this will reveal the circumstances that strengthen or weaken the association between driver state and driver performance. Evidence that it acts as a mediator suggests a more direct relationship between driver state and driver performance. To examine the effect of a driver distracted condition on vehicle state, the relationship between distracted condition as an independent variable and lane position as a dependent variable is modeled taking into account the eye-steering correlation as a third variable that can change the association between them. The statistical significance of the parameters indicates the role of correlation parameter as mediator or moderator. If the correlation parameters (correlation coefficient or time delay) mediate the effect of distracted condition on lane position, then they could act as prospective indicators of lane keeping performance to predict lane departures. To examine this assumption, the sensitivity of the eye-steering model to lane departures is tested.

#### Expected contributions

The major theoretical contributions of this dissertation will be: 1) a description of the effects of visual-motor performance in driving evaluated through the degree of correlation and time delay between eye and steering movements. This will allow deeper understanding of the role of eye-steering coordination in driver performance; 2) the effect of distractions on the degree of eye-steering coordination; and 3) the prediction of lane keeping degradation by the driver eye glance and steering behaviors to anticipate near crash type breakdown in steering control.

The practical contribution of this dissertation will be to help design systems capable of providing a diagnostic measure of distraction in advance of mishaps. The development of a prospective indicator of driver impairment can be helpful in mitigating and preventing many impairment-related crashes. The relationship between eye glance patterns and vehicle control metrics, i.e., steering, could allow the prediction of driver

performance degradation and use this prediction for the distraction detection algorithm design. In addition, the use of different sources, i.e., eye and steering signals, will increase robustness and accuracy of prediction and will allow the continuous evaluation of driver distraction in case of failure of one of the input sources.

## CHAPTER 2. BACKGROUND AND LITERATURE REVIEW

### Driver distraction

Driver distraction is a form of “inattention that diverts driver’s attention away from the activities critical for safe driving toward a competing activity” (Lee, Young et al., 2008, p. 33). These non-driving activities place additional demands on drivers that vary in their nature and could impact driver performance differently. In general, driving performance declines to the extent that the competing task shares resources with the driving task. Which activities would most likely cause an impaired performance and increase accident crash risk? When should a driver be considered distracted? How do distracting activities influence driving behavior? These are the issues discussed in this section.

#### Distraction sources and drivers’ involvement

Of the various types of transportation-related fatalities for 2007, passenger cars were the most common (38.4%), followed by light-truck (28.8%). As compared, the fatalities in general aviation were only 1.1% (TSAR, 2008). An important contribution to fatal car crashes is distraction. An analysis of the data from the 100-car study found that driver distraction associated with secondary task performance contributed to 43% of crashes out the 78% of crashes caused by inattention (Dingus, Klauer et al., 2006). These statistics indicate the influence of distraction on driving safety. This section discusses the most frequent types of non-driving activities observed in naturalistic studies and evaluated crash/near crash risk caused by these activities.

Driving task is a complex visual/manual multitask activity (Regan, Lee et al., 2008). It requires a driver to look to the roadway, at the instrument panel, and at the mirrors and windows to assess the environment. The visual assessment of the road and the environment plays a critical role in the safety of driving. The higher driving demand the more attention to the driving task is needed. The demands of the driving task depend



on factors such as traffic density, weather, and presence of passengers (Cooper and Zheng, 2002; Strayer, Drews et al., 2003; Sayer, Mefford et al., 2005). Any additional non-driving activity can decrease a driver's situational awareness, which leads to diminished driving performance and increased crash risk. The effect of the secondary task on crash risk depends on many factors, which include source of distraction (e.g., cell phone, objects or events inside or outside the vehicle), type of distraction (e.g., visual, cognitive, and auditory), driver personal characteristics (e.g., experience, age), and traffic demands. When driving demands are low, tasks that place little demand on drivers may be effectively time-shared with the driving task and cause little or no degradation in driving performance (Lee, Young et al., 2008). In general, the degree with which distraction will contribute to crash risk depends on roadway demands at the time of task involvement and is a function of frequency of drivers' engagement in a particular activity and degree to which this activity contributes to crash risk. Both factors are discussed in this section.

Driver distraction research is focused on identifying the most common activities and conditions under which engagement in secondary tasks is most likely to distract drivers and, as a result, impact driving performance and safety. Observational studies reveal that distraction is a common component of everyday driving. Drivers are involved in competing activities in about one-third of time during their everyday driving (Sayer, Mefford et al., 2005). The first three columns of Table 1 summarize two studies (Stutts and Hunter, 2003; Sayer, Mefford et al., 2005) that show the activities drivers perform while driving. Almost all drivers manipulated vehicle controls (such as air conditioning or window), music/audio knobs, reaching for objects inside the vehicle, and had their attention drawn to events or objects outside the vehicle. About three-fourths ate or drank something or conversed with a passenger. Both studies found that drivers spent approximately 15% of their total driving time engaged in conversation with passengers and an approximately equal amount of time engaged in other activities.

Table 1. Summary table of drivers' engagement in secondary task and its influence on crash/near crash likelihood

Observed behavior	Sayer et al., 2005 (36 drivers)	Stutts et al., 2003 (70 drivers)		Klauer et al., 2006 (101 drivers)	
	% of time	% of time	% of subjects	Odds ratio (95% CL)	PAR%* (95% CL)
Conversation with passengers	15.3	15.5	77.0		
Child in rear seat				0.33 (0.04:2.40)	
Eating	1.9	1.5	71.4	1.57 (0.92:2.67)	2.15(1.85:2.46)
Drinking				1.03 (0.33: 3.28)	0.04(-0.10:0.18)
Music/radio on		71.4			
Manipulating audio controls		1.1	91.4	0.55 (0.13:2.22)	
Inserting CD				2.25 (0.30:16.97)	0.23(0.15:0.32)
Reaching for something		2.3	97.1	1.38 (0.75:2.56)	1.23(0.96:1.50)
Reaching moving object				8.25 (2.50:31.16)	1.11(0.97:1.25)
Talking on cell phone	5.0	1.2	30.0	1.29 (0.93:1.80)	3.56(3.10:4.10)
Dialing/answering cell phone	0.1	0.2	42.8	2.79 (1.60:4.87)	
Reading		0.8	40.0	3.38 (1.74:6.54)	2.85(2.60:3.10)
Smoking	0.6	1.5	7.1		
Grooming	6.5	0.4	45.7		
Applying makeup				3.13 (1.25:7.87)	1.41(1.23:1.59)
Combining hair				0.37 (0.05:2.65)	
External distraction		2.3	85.7	3.70 (1.13:12.18)	0.91(0.77:1.05)

\* Population Attributable Risk Percentage

The crash/near-crash likelihood associated with different non-driving activities is presented in the last column of Table 1 (Klauer, Dingus et al., 2006). Odds ratio shows how much the event, i.e., crash/near-crash, is more likely to occur while performing non-driving task compared with normal (non-distracted) driving. Some activities such as reaching for a moving object, looking outside (external distraction), reading, applying makeup, and dialing cell phone had the highest odds ratio which means that performance

of these tasks is very dangerous. This table shows that more than 85% of drivers were distracted by outside objects or events; and this type of distraction (external) can increase crash risk by three times (OR of 3.70 with CI: 1.13,12.18). Other activities, such as handling a CD, talking on the cell phone, and reaching for an object, might not actually increase crash likelihood or near-crash involvement. It is important to note that any activity has potential to increase crash risk depending on driving demands.

The percentage of crashes and near-crashes that could be attributed to the specific behavior was assessed through population attributable risk percentages (PAR%). Some odds ratios may have a very high individual risk; however, that behavior does not occur frequently and therefore attributes to very few crashes in the population. For instance, reaching for a moving object, external distraction, reading, applying makeup, and eating have high odds ratio but these factors do not account for a large percentage of actual crashes and near-crashes (Table 1). This identification and assessment of the most common activities that affect safety and contribute to the crashes can help identify the degree of distraction.

#### Types and consequences of distraction

Distraction is a type of inattention when a driver is involved in non-driving activities can impact safe driving. These activities place additional demands on drivers that vary in their nature and might affect visual, manual, auditory, and cognitive attentional resources. Driving performance declines to the extent that the competing task shares resources with the driving task (Wickens, 2002; Horrey and Wickens, 2004). The distraction caused by interacting with in-vehicle devices while driving has been shown to significantly impair driver's ability to maintain speed, lateral position on the road (Horberry, Anderson et al., 2006; Salvucci, Markley et al., 2007), and reaction time (Lansdown, Brook-Carter et al., 2004). It can also impair drivers' visual search patterns and decision-making processes and can increase the risk of being involved in a collision.

Based on the effect of the secondary task on driver performance, the focus of different research was on two types of distraction: visual and cognitive. These two types of distraction can be described as “eye-off-road” and “mind-off-road”, respectively (Victor, 2005). Both categories can undermine drivers’ performance. Visual distraction occurs when drivers look away from the roadway (e.g., to adjust a radio). The visual-manual tasks led to 40 percent less time focused on the road and affected driving performance more than auditory-vocal tasks (Angell, Auflick et al., 2006). The off-road glances associated with using in-vehicle devices can lead to large and frequent lane deviations, uneven steering control, and slow response to lead vehicle braking (Donmez, Boyle et al., 2006; Zhang, Smith et al., 2006; Donmez, Boyle et al., 2007).

In contrast to the visual distraction, cognitive distraction has a more subtle effect on drivers. One consequence is it leads drivers to allocate visual attention to the road center and decrease looks at the periphery. These behavioral changes diminish drivers’ ability to detect targets across the entire driving scene (Recarte and Nunes, 2003; Victor, Harbluk et al., 2005; Reyes and Lee, 2008). Cognitive distraction associated with auditory e-mail systems, math calculations, or holding hands-free cell phone conversations delays driver response to hazards (Horrey and Wickens, 2006). During simulator driving, the reaction times of the drivers conversing on cell phones increased and the drivers were more likely to crash compared with drivers talking to passengers (Charlton, 2009). This difference showed the effect of additional cognitive demands placed on drivers talking on the cell phone. Cognitive distraction impairs both implicit perceptual memory and explicit recognition memory for objects even when drivers look at the objects (Strayer, Drews et al., 2003).

Numerous studies examined the effect of different types of distraction represented by different activities on the driver performance. The CAMP (Crash Avoidance Metrics Partnership) and HASTE (Human machine interface And the Safety of Traffic in Europe) research programs provide substantial evidence to distinguish between visual and

cognitive distraction (Carsten, Merat et al., 2005; Angell, Auflick et al., 2006). This differentiation could help to find specific ways for distraction mitigation and prevention.

### Distraction detection, mitigation, and prevention

The impact of competing activities on crash risk can be regulated in different ways: optimizing design of in-vehicle systems, providing retrospective feedback to the driver about driving performance to induce positive behavioral changes, and designing real-time distraction detection system to provide concurrent feedback for immediate improvement (Regan, Lee et al., 2008). The real success of these systems would be in their ability to predict state of distraction based on driver perception and control metrics. This approach is directed to predict driver distracted condition and alert the driver before driving performance degrades.

### Distraction detection

This section discusses some considerations in developing distraction detection systems, i.e. distraction identification and detection algorithms. The choice of metrics indicative of distraction depends on the type of distraction. These different types require different algorithms to quantify the level of distraction.

### Indicators of driver distraction

Numerous studies have examined different types of assessment metrics and algorithms that could be sensitive to the distraction. Drivers react to the changes of the roadway situation by modulating the lateral and longitudinal controls: steering wheel, brake pedal, and accelerator pedal. Steering is an important metric of the vehicle control because of its potential of providing a very timely indicator of distraction. Steering wheel changes mostly increased for both visual and cognitive distractions in comparison with normal (non-distracted) driving but in different ways: a visual secondary task leads to increased steering wheel movements in a wide range of amplitudes (i.e., 2-6 degrees),

whereas cognitive tasks cause corrective movements with small amplitudes (less than 1 degree) (Östlund, Peters et al., 2006). Assuming undistracted drivers apply smooth steering adjustments suggests that steering entropy might measure the predictability of steering wheel movements and distraction associated with abrupt movements (Nakayama, Futami et al., 1999). Distractions can cause abrupt steering corrections to keep the car in the safety boundary. The mismatch between the predicted steering wheel position associated with a smooth response and the abrupt input has been shown to be sensitive to both visual and cognitive distraction: involvement in a secondary task increased entropy.

Vehicle control inputs of the driver affects vehicle state measured through lane position, headway, and speed. Keeping a vehicle in the safety margins denotes that a driver successfully performs the driving task. A vehicle position in the lane could be used as an indicator of driver performance. Lateral position changes relative to the centerline have been reported in the majority of experiments addressing visual distraction. Generally, lateral control degrades with increasing level of visual distraction, but it becomes more precise under cognitive distraction (Engstrom, Johansson et al., 2005; Östlund, Nilsson et al., 2006). This can imply that the involvement in the visual task can lead to a more degraded driving performance compared with cognitive distraction.

Time and distance measures of headways could be used to evaluate the effect of distraction on driver safety perception. Distractions influence speed and headway maintenance. Östlund et al. (2006) found visual distraction leads to decreased speed and cognitive distraction did not influence speed significantly. Similar to speed, headways increased under visual distraction and maintained relatively unchanged with cognitive distraction (Östlund, Nilsson et al., 2004). On the other hand, the speed variations with tendency to decrease were found in numerous studies with hands free and handheld cell phones (Patten, Kircher et al., 2004; Rakauskas, Gugerty et al., 2004). These changes in speed and headway were caused by the driver compensatory behavior to manage the increased attentional demands.

Eye movement metrics such as glance duration, frequency, position (horizontal and vertical), and type (on-road and off-road), were found sensitive to the demands of driving and secondary tasks. Changes in glance pattern measured through these metrics can indicate presence of distraction. Moreover, the glance pattern while performing cognitive tasks is different from what it is for visual tasks. The frequent and/or long off-road glances indicate visual distraction and concentrated glances toward the road center indicate cognitive distraction (Victor, Harbluk et al., 2005). Distracted drivers check the mirrors and the speedometer much less frequently while performing secondary cognitive and verbal tasks relative to no task conditions and spend more time looking to the center of the road (Recarte and Nunes, 2000; Harbluk, Noy et al., 2002). This gaze concentration was reflected in reduced horizontal and vertical variability of gaze positioning as well as longer duration of on-road glances.

In summary, visual and driver performance metrics can be used for distraction detection (Table 2). The differentiation of these two types of distraction could be based on differences in visual behavior and driving behavior. Some algorithms developed to diagnose both types of driver distraction are discussed below.

Table 2. Summary of distraction assessment through visual and driver performance metrics

	Visual distraction: “ <i>eye-off-road</i> ”	Cognitive distraction: “ <i>mind-off-road</i> ”
Visual behavior	frequent and long off-road glances	visual attention allocated to the road center
Vehicle control	abrupt steering movements with large (2-6 degrees) amplitude, large steering entropy	corrective movements with small (less than 1 degree) amplitude, small steering entropy
Vehicle state	large and frequent lane deviations speed decrease and headway increase	unchanged or small lane variation speed does not changed significantly

### Distraction detection algorithms

Visual and cognitive distractions are fundamentally different types of distraction and different algorithms are required to predict degradations in driver performance. The combination of different glance behavior metrics has been considered in predictive models for the risks associated with visual distraction. The goal of the visual distraction prediction models was definition of a single visual demand metric that can combine duration of off-road glances, their frequencies in the time-window, and their eccentricity to assess the degree of distraction. These metrics mainly evaluate visual demands during a task, a fixed time-window, or a moving time-window. Cognitive distraction identification is a more complex process than visual distraction because the mechanisms involved in cognitive impairment have not been precisely described. For the detection of cognitive distraction, combination of eye movement and performance measures were summarized across a relatively long time interval.

The combination of glance duration and frequency in Percent Road Centre (PRC) or Total Glance Duration (TGD) successfully differentiated between visual and cognitive distraction (Victor, 2005). The PRC was the most sensitive visual task measures followed by total glance duration. PRC increased with cognitive tasks and decreased with visual tasks compared with normal driving. The differences in visual task difficulty were more pronounced with TGD. These metrics were proposed to be a good indicator of distraction. Further study showed that off-road TGD can evaluate crash/near-crash risk: total off-road glance duration of less than two seconds in a six-second window did not increase crash/near crash risk but it was doubled when the duration was greater than two seconds (Klauer, Dingus et al., 2006).

Senders et al. (1967) developed an approach for describing uncertainty about the driving environment as an effect of glances away from the roadway, where uncertainty grows as a 1.5<sup>th</sup> power function of the occlusion duration. Another algorithm used a weighted combination of the current off-road glance duration and the total off-road



glance duration in the time-window of three seconds. The threshold of momentary value of distraction for less-salient alarm (one-color strip) was 2.0 seconds and 2.5 seconds for more salient alarm (two-color strip) (Donmez, Boyle et al., 2006; Donmez, Boyle et al., 2007). Engström and Mårdh (2007) developed an algorithm that combined duration, history, and eccentricity of off-road glances to estimate the total visual demands of a task. The visual demands were described as the summation of the product of the 1.5<sup>th</sup> power of duration with a penalty for eccentricity of the glance relative to the road center for each off-road glance. A similar summation of off-road glances occurring in a time window was used to quantify visual distraction to support a lane-keeping assistant system (Pohl, Birk et al., 2007).

Another approach of integrating the effect of glances over time is to define a buffer that reflects drivers' capacity to respond (Kircher, Kircher et al., 2009). The algorithm integrates three types of glances over time: on-road when drivers glance toward the "field relevant for driving" (FRD), driving related (e.g., mirrors or speedometer), and off-road glances. The level of the buffer increases during on-road glances and decreases during glances away from the road in a linear manner. During latency phase of 0.1 sec for the transition from off-road to FRD glances and 1 sec for transition from on-driving to FRD glances, the buffer level remains at the current position before increasing. Maximal buffer is two seconds, and when the buffer goes to zero, the driver is considered distracted.

Cognitive distraction degrades longitudinal control and hazard perception, but is less risky, less consistent, and more difficult to identify compared to visual distraction. The detection of cognitive distraction needs integration of a number of eye movement measures (e.g., blink frequency, fixation duration, and pursuit measurements) and performance measures (e.g., steering wheel movements and lane position) summarized across a relatively long time interval. Data mining techniques have successfully detected cognitive distraction using many measures. A decision tree technique was applied to

estimate driver cognitive workload from eye glances and driving performance measures (Zhang, Owechko et al., 2004). Support Vector Machines (SVMs) and Bayesian Networks (BNs) successfully identified the presence of cognitive distraction from eye movements and driving performance (Kutilla, Jokela et al., 2007; Liang, Lee et al., 2007; Liang, Reyes et al., 2007). These approaches assessed the discrete state of cognitive distraction, but did not predict the continuous level of distraction. Moreover, cognitive distraction detection algorithms need to be customized for different drivers, making them more difficult to implement (Liang, 2009).

All these approaches aim at detecting state of distraction in real time based on visual behavior or driving performance metrics. These algorithms could be found helpful in distraction detection system design but the real success of these systems would be in their ability to predict state of distraction based on driver perception and control metrics. This consideration could predict driver intention to get involved in distracting activity and alert the driver before driving performance degradation happen.

#### Distraction mitigation and prevention

The impact of distraction on crash risk can be regulated by providing feedback for immediate (distraction prevention) and/or future (distraction mitigation) driving performance improvement. Distraction mitigation and prevention can be implemented through workload management and distraction mitigation functions (Engström and Victor, 2008).

The real-time workload management function (distraction prevention) assumes information management according to the current states of a driver and driving environment. Driving demand changes cause driver workload fluctuations. When the workload is beyond a certain point, additional demands can degrade safety. The purpose of the workload management function is to preserve safety by prioritizing, rescheduling, and locking out potentially distracting vehicle functions, as well as adapting its format.

For instance, the system can interrupt a phone call while performing a lane change maneuver (lock out function) or the mode of information presentation could be changed from visual to auditory if the driver is highly visually loaded.

The goal of distraction mitigation is to provide feedback to the driver to enhance immediate or future performance. Real-time distraction mitigation function assumes redirection of driver attention to the driving scene. Concurrent (immediate) feedback would alert the driver to a failure of proper reaction to the current event with the purpose to enhance immediate performance. Retrospective feedback (after the trip) would provide driving performance assessment and help the driver induce positive behavioral changes. Four major timescales were considered for a feedback: concurrent (milliseconds), delayed (seconds), retrospective (minutes, hours), and cumulative (days, week, months, years) (Donmez, Boyle et al., 2008).

The real-time warning can enhance driving performance immediately by modulating distracting activity (Donmez, Boyle et al., 2007). The functions such as locking and interrupting (distraction prevention) and advising (distraction mitigation) successfully mitigated visual and auditory distractions (Donmez, Boyle et al., 2006). The negative impact of the immediate feedback is that it may impose more workload on a driver in addition to the already highly demanding situation (Donmez, Boyle et al., 2008). It can also create inappropriate dependence on a feedback and provoke distracting behavior. For example, a driver might feel protected by a system capable of generating alerts about critical situations and might become involved in the distracting activities more often. A very important issue is the accuracy of distraction detection because a high number of false alarms (false adaptation) could lead to system mistrust (Donmez, Boyle et al., 2006). Consequently, false adaptation and diminished trust can undermine driver acceptance of the system (Parasuraman, Hancock et al., 1997). Another issue is that a driver's limited capacity can make it difficult to perceive all the incoming information

and understand the reasons for the real-time feedback while driving. This problem could be solved by providing summary information after the trip.

Retrospective and cumulative feedback provides information about inappropriate behavior immediately after the trip or over many trips. An advantage of this feedback is that the provided information would be more detailed than delayed and concurrent feedback. This information can be highlighted and classified based on the most persistent behavior that led to the diminished performance. In addition, retrospective and cumulative feedback will avoid overloading the driver during the trip, at the cost of not achieving the immediate improvement while driving. McGehee, Raby et al. (2007) obtained the dramatic positive effect of the cumulative feedback on teenagers' driving behavior when teens and their parents systematically reviewed the driving information in the form of weekly graphical report cards and videos.

These different feedback types can be successfully combined. This combined feedback will provide information in different timescales and levels of detail. This can improve immediate driving performance and help drivers to learn about inappropriate driving behavior that can lead to the crashes (Donmez, Boyle et al., 2008). In all cases, the overall success of a distraction detection system would be mainly based on the system's ability to correctly detect distraction.

#### Current distraction detection systems

There is a growing interest from automobile makers in the design and implementation of distraction detection systems. Several distraction detection and mitigation systems are on the market or exist as advanced prototypes: Saab's ComSense and Driver Attention Warning System (AttenD), Volvo's Driver Alert Control, the Delphi's SAVE-IT system, Lexus' Driver Monitoring System, Toyota's Wakefulness Level Judging System, and Mercedes-Benz's Attention Assist (Table 3). These systems intend to detect drowsiness, distraction, and changes in cognitive state. The algorithms

that were developed to evaluate and predict driver state use different metrics and detection methods. The general approaches applied in the algorithms are presented above. Some distraction detection algorithms are based on driver visual behavior and use head pose or eye movement metrics, whereas others evaluate driver performance and use vehicle state or driver control metrics. Table 3 summarizes the systems intention to detect, mitigate, or prevent the specific type of distraction and inputs used for this purpose.

The combination of these variables could increase the sensitivity of the distraction algorithms and reduce the number of false alarms. Drivers can successfully perform secondary tasks without driving performance degradation under low demanding traffic conditions. The system based on the visual behavior metrics will diagnose distraction but it is more likely that a driver would not accept an alert about distraction. The system, based on the driving performance measures, could diagnose a maneuver performance, i.e., lane change, as a change in driver state and issue a false alarm. On the other hand, the same system could miss a cognitive distraction.

The combination of different metrics can not only improve the algorithm but can also differentiate the types of inattention. For example, eye movement data could be combined with vehicle path data to distinguish between drowsiness (e.g., eyes directed towards the road during path departures) and distraction (e.g., eyes directed away from the road during path departures). In addition, this approach will allow continuous evaluation of driver distraction in the case of a failure of one of the input sources.

Table 3. Distraction detection systems

Systems	System intention	Input into the system				Countermeasure
		Distraction evaluation metrics			Environmental conditions	Mitigation / Prevention
		Eye glance / Head pose	Driver control	Driver performance		
Wakefulness Level Judging System (Toyota)	drowsiness detection	head pose		speed, lane positioning	road type	acoustic / corrective steering
Attention Assist (Mercedes-Benz)	drowsiness detection		steering, pedal operation	speed, longitudinal and lateral acceleration	wind, road surface, road conditions, time of day, ambient temperature	acoustic & visual / n/a
Driver Alert Control* (Volvo)	drowsiness detection			speed, lane positioning	road geometry, stationary objects, dynamic objects	acoustic & visual / n/a
Driver Monitoring System (Lexus)	drowsiness & distraction detection	head pose, eye glance			obstacle ahead	acoustic / emergency braking
ComSense (Saab)	distraction prevention		steering, brake pedal position	speed, turn signal status,	headlamp status, wiper status	no warning / call interruption
Driver Attention Warning System (AttenD)** (Saab)	drowsiness & distraction detection	eye glance, eye blink			road type	acoustic, visual, seat vibration / n/a

\*eye glance characteristics are considered in future prototypes

\*\* the algorithm is under development

### Perception and action in driving

The perception-action control process plays a central role in driving (Regan, Lee et al., 2008). Information flow about the roadway and traffic situation guides a driver to control the vehicle. Interruptions of this information flow could cause diminished vehicle control and, as a result, lane keeping degradation. Different visual and driver performance metrics were examined to detect distraction, but the relationship between them was not established. The examination of the mechanism of action preparation based on visual information can reveal the relationship between eye movement and vehicle control. Changes in this relationship could identify distraction.

In vision-guided tasks, including driving, the function of vision is to provide information to support action. Action preparation and execution could be conventionally represented by three systems: gaze, motor, and visual (Figure 2).

The gaze system is responsible for locating and fixating task-relevant objects (e.g., bend, leading car, or stop sign); the motor system of the limbs carries out the task (e.g., steering, braking); and the visual system supplies information to those two (Land, 2009). Thus, the role of visual system is crucial in this schema: it reflects the scene of the world to provide information to the gaze and motor systems for action preparation and execution respectively. The function of the visual system in action performance and particularly in driving is discussed in this section.

Visual information from the outside world provides instruction to the neuromuscular control system through the perception (path from visual to gaze and then to motor system in Figure 2). This coordination between perception and action can be observed in everyday activities such as driving, walking, reading, drawing, and playing ball games (Land, 2006). The eyes typically search for

information about objects of interest to establish their locations and moves to those objects about a second before each act initiation. People chose points for eye positioning before an action as the best ones for the spatial-temporal demands of the task (Land, 1993; Land and Tatler, 2001). This glance behavior is based mostly on the role of the objects in the task and not their salience. The eyes seldom move to objects that are irrelevant to the task. This coordinated attention-eye movement indicates the preparation for action (path from visual to gaze system on Figure 2).

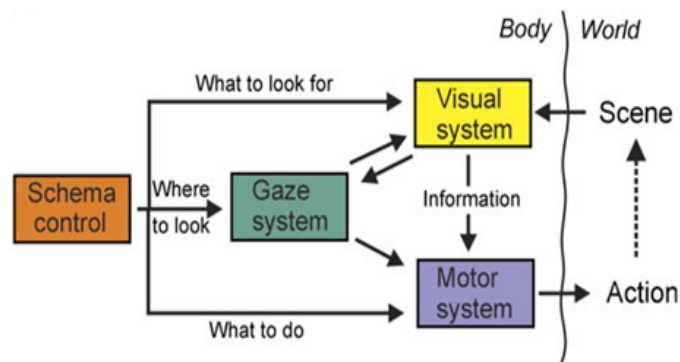

Figure 2. Relations of the schema, gaze, visual, and motor systems during the performance of a visually controlled action (Land, 2009)

In driving, visual information supports vehicle control. Different studies examined the choice of fixation points that provided visual information to guide steering. The choice of these points depends on a driving environment. For curve negotiation, drivers fixated glance location on the tangent point of an approaching bend about 80% of the time to get the estimates of the bend's curvature (Land and Lee, 1994). The need for continuous information to control a vehicle forces drivers to direct both foveal and peripheral vision to select information from driving environment. The gaze direction precedes steering wheel movements by about 0.8 seconds. This lag provides drivers with a comfort margin to perceive the path and



plan the future action. The vanishing point was fixated on a straight road, and a point connected to the lead vehicle was a target point for the car-following task performance (Land and Horwood, 1995). The near-region fixation point provided information for lane keeping and monitoring vehicles and surrounding objects (Land & Horwood, 1995).

Thus, the need to use distant vanishing and tangent points or points close to them on the inside edges of bends increased on open roads at high speeds where demands for dealing with other road users and potential obstacles were reduced. In urban areas at low speeds, drivers spent most of their time looking at the near places from which they needed to obtain information, e.g., cars, pedestrians, road signs, and traffic lights and they use peripheral near point for steering (Land and Tatler, 2001).

Specific eye movements observed in driving provide information about the roadway and traffic situation to control the vehicle. These coordinated eye movements and vehicle control actions support safe driving. Changes in this coordination might lead to diminished vehicle control and to dangerous changes in vehicle state, such as lane departures.

#### Intermittent control

The role of vision in the motor control, i.e., limb movements, has been studied for more than 100 years. The accuracy of visually guided actions depends on many factors and one of them is temporal processing delay. The shorter the duration between picking up visual information and using this information for motor action, the more precise the movement (Carlton, 1992). A delay between visual information and motor action has been explained in a reaction time paradigm (Donders, 1969) and by the visual processing time associated with the control of ongoing movements (Carlton, 1992). Reaction time is defined as an

information processing time required to react to stimuli. It is almost constant (190-210 ms) over a range of stimuli, responses, and subject variations. Visual processing time varied with subjects' experience and by the type and size of the error produced during the movement. In general, the visual processing time was found to be considerably shorter than the information processing time, when the visual information represented feedback from an ongoing movement or when the time of the visual event was reasonably certain.

The delay between visual feedback about the position of the limb in space and movement toward the target was studied to understand the stages of visual information processing and action planning. The whole path toward a target consists of sub-movements that are intended to reduce error developed in the previous steps (Miall, Weir et al., 1988). The sub-movement performance integrates two control strategies: feedforward control that is used to preprogram the future path and feedback control that uses visual information about current limb and target positions to make corrections (Stein and Glickstein, 1992).

Both feedforward and feedback control can occur in a continuous control fashion or when the tracking of a continuously moving target is broken up into a series of intermittent corrections. The exact mechanism of this sampling process is not entirely clear but it could be supposed that the visual processing delay plays a role in this discretization. The sampling of the visual information should be frequent enough to prevent the decay of the previous sample representation and long enough to delay further programming until the results of the previous movement are fed back and evaluated (Miall, Weir et al., 1988). In this intermittency paradigm, the duration of visual information processing time reflects the time necessary for the visuomotor system to evaluate an error between current and target positions and initiate a correction to the ongoing movement.

The intermittency paradigm explains task performance during visual occlusion or inattention when information about a target is eliminated. In the absence of the visual information, perceptual memory enables people to memorize target trajectories and to track them almost perfectly (Elliott, 1992). This visual representation of the movement environment persists for some time following visual occlusion and this representation allows continuously guiding limb movement. The information representation about the movement could persist more than 2 seconds after visual occlusion onset and then decay very rapidly with further loss of information for up to 10 seconds (Elliott, 1992; Stein and Glickstein, 1992). This visual representation of the movement environment could serve as an acquired “skill” and temporarily substitutes for a continuous visual information. For this reason, visual occlusion that exceeds this two-second threshold would cause diminished performance. Thus, visual information intermittency in movement control related to the processing of visual feedback resulted in relative discontinuity in movement.

The vision system provides information to support action preparation and execution. The degree of coordination between visual and motor functions could influence performance and be used as a driver state indicator.

#### Eye-steering coordination

Several studies have examined the coordination between visual and motor functions in driving and found that it plays crucial role in driving performance. Eye-steering coordination was observed for drivers approaching bends. Eye movements precede steering movements by about one second. The coordinated eye and hand movements were explained from a sensory point of view: visual information from the fixation point allows computation of the steering movements to assist tracking (Land and Horwood, 1995; Land, 2006). This assumption

describes how visual input (e.g., tangent point of the road curve) can be used by a driver to initiate an appropriate motor response.

Another assumption for eye-steering coordination is that regardless of precisely which visual cues are used to guide movement, the eye movement itself contributes to the steering pattern. In this case, the coordinated eye and hand movements were explained by the oculomotor controller implying that the ocular control system feeds into the manual control mechanism to assist tracking (Miall and Reckess, 2002).

When drivers were instructed to keep their gaze on the center of the screen while driving on the curvy road, they spent more time steering straight than they did in normal driving conditions (Marple-Horvat, Chattington et al., 2005). This disruption of eye-steering coordination damaged driving performance measured through task completion time indicating the importance of this correlation. With the reduced visibility when the tangent point on a left-hand bend was not identifiable, the drivers who moved their eyes to that area performed better than those who preferred to focus on the center part of the road (Wilson, Stephenson et al., 2007). These results led to the suggestion that steering performance arises from eye movements, rather than from the acquired visual information and the eye movements could be considered as an input to the steering controller.

The degree of coordination between horizontal eye movements and steering is highly consistent for both individual drivers and for different drivers travelling the same route (Chattington, Wilson et al., 2007). The high covariation with eye movements ( $r=0.84$ ) explained 71% of steering movements on the curvy road. Head movement explained smaller percent of steering behavior – only 29%.

The correlation between eye and steering signals was affected by driver impairment, and the driving performance degradation was associated with correlation degradation. The correlation was reduced when drivers were exposed to

an attentional narrowing through high stress (Wilson, Chattington et al., 2008). The horizontal eye movements were more focused in the central part of the road scene in the high-threat condition than in the low-threat condition while steering movements were not affected. The coordination between eye and steering movements deteriorated during drunk driving. The most intoxicated drivers were the most affected in terms of their eye-steering coordination and experienced the most frequent and most serious crashes (Marple-Horvat, Cooper et al., 2008). The time lead between eye and steering movements decreased from 710ms to 402ms with an increase of alcohol level from 0mg/100ml to 35mg/100ml.

These results indicate that (1) eye-steering coordination is highly consistent in natural driving on curvy roads; (2) eye movements precede steering; and (3) definition of a normal eye-steering coordination can help to identify impaired coordination that could be a result of different factors such as distraction, fatigue, and alcohol.

Based on these findings, a measure of correlation between eye and steering movements can help in driver state identification. However, state identification depends on the degree of correlation between eyes and steering signals for different eye movements. For instance, as discussed above, the degree of eye-steering correlation was very high on curvy roads for normal (non-distracted) driving: drivers moved eyes to guide steering. While driving on straight roads, drivers move their eyes less frequently to support their steering and this can cause weak correlation between two signals. Shifts from off-road to on-road glances might be associated with subsequent corrective steering movements. These coupled movements will be associated with lapses in vehicle control and can designate visual distraction.

Driving environment can also influence this correlation. Non-distracted driving in urban environment could cause weak correlation between eye

movements and steering. The substantial visual information causes eye movements from driving scene to different locations but does not require the intensive steering movements. In this situation, the eye movements reflect glances to and away from the road to monitor pedestrians, intersections, and other hazards and do not guide steering. Thus, it is important to examine not only the changes in eye-steering correlation but also the causes of these changes.

### Driver control modeling through visual information

The abovementioned findings show that eye and steering movements are tightly linked: visual information about future path supports steering and can be used for modeling steering control. The control-theoretic models of driving were developed to predict driver-vehicle behavior. To represent a driver in a path-tracking scenario, different approaches such as continuity and intermittency of movements and information were considered. Some of these approaches are presented in this section. All these efforts are addressed to define a mathematical model of visuomotor performance. Accurate description of driver behavior for normal (non-distracted) driving could be helpful in distraction prediction: changes in model parameters or changes in model fit could indicate distraction.

Early models of a driver as an adaptive controller were focused primarily on control-theoretic descriptions of steering control in lane keeping and curve negotiating tasks. These models had compensatory, pursuit, and precognitive control structures (McRuer, Allen et al., 1977; Donges, 1978). In compensatory behavior, the steering movement is a function of errors of vehicle position in the lane: the feedback of position error is an input into the vehicle control system. The pursuit control has a feedforward element: a driver has learned to compensate for the vehicle dynamics and can anticipate the desired path. The precognitive control assumes that a driver can generate steering movements based on previously

learned control movements. The approach used in compensatory and pursuit control assumes that visual feedback is available for continuous error correction and path monitoring. i.e., this approach uses the *visual information-vehicle control* relationship. The examination of this relationship can help understand the role of visual feedback in driving tasks more deeply, i.e., which visual information guides steering and how visual occlusion affects vehicle control. The following studies represent the attempts to answer these questions. Modeling *visual information-vehicle control* relationship could elicit if changes in this relationship predict distraction.

The driver steering behavior with various degrees of occlusion was examined through two different modeling approaches (Hildreth, Beusmans et al., 2000). The first model assumed that drivers continually adjust steering to regulate the state of perceptual variables relevant to the task such as lateral position, heading, and their temporal derivatives. The second model considered continual steering toward the virtual target (similar to tangent point for the curve negotiation). Both models were considered reasonable for steering control. They reproduced the detailed shape of human steering profiles and similar degradation in performance with longer occlusion periods across the drivers. The target model, however, was found to be more intuitive because the relationship between target movement and the driver's response could be easily adapted to other steering tasks.

A model of steering control based on two salient points in the near and far regions of the roadway successfully predicted steering profiles for corrective steering maneuvers, lane change, and curve negotiation on winding roads (Salvucci and Gray, 2004). The near point located in the center of the road allowed the model to monitor both lateral position and stability. The far point allowed the model to predict steering angle for the upcoming road profile.

The concept of intermittency of visual information processing and steering control was applied in modeling of a predictive steering driver control (Roy, Micheau et al., 2009). The intermittency of steering control was based on the assumption that the muscle torque increases gradually, and the wheel angle reaches the desired reference angle with a specific time lag associated with the human neuromuscular system. The model with intermittent control behavior was found closely mimic driver steering control behavior. This approach showed that the intermittence period could vary with the driver workload or driving environment (e.g., road curvature). The eye-steering system defined for normal non-impaired driving on a specific type of road can differentiate driver impaired state (high workload, fatigue, or distraction) when data from the impaired state is used. This variation of information processing time could assume that the parameters of the model will change with driver state indicating driver high workload or distraction.

Another attempt of modeling driver steering behavior based on visual information was done through considering perception-action aspects of driving task performance. An integrated driver model developed in the ACT-R (Adaptive Control of Thought-Rational) cognitive architecture is focused on the processes of control, monitoring, and decision making for driving tasks (Salvucci, 2006). The cognitive architecture is based on chunks of declarative knowledge and condition-action production rules that operate on these chunks. The model control component linked perceptual variables (the visual cues of the environment perception) to vehicle control actions – steering, acceleration, and braking. The control law for steering angle  $\varphi$  was expressed through a steady far point  $\Delta\theta_{far}$ , near point  $\Delta\theta_{near}$ , and near point at the center of the lane  $\theta_{near}$

$$\Delta\varphi = k_{far}\Delta\theta_{far} + k_{near}\Delta\theta_{near} + k_I\Delta\theta_{near}\Delta t$$

As with the models discussed above, this model defines the relationship between driver performance and continuous visual information. This approach also assumes



that interruptions in visual information could cause changes in the model performance.

All these efforts in driver-vehicle system development address the goal of predicting driver performance based on visual behavior. An accurately developed model for normal driving can be a practical tool for real-world applications such as distraction detection systems. Distraction prediction will be based on changes in model performance: it will degrade with visual information interruptions.

#### Models based on time series and system identification approaches

The findings that eye and steering movements are tightly linked indicate that the driver eye-steering behavioral model can be defined with eye movement signal as an input and steering movement as an output. The black box system modeling will identify a transfer function that defines the relationship between these two signals. The present position of steering wheel can depend not only on eye signal but also on past values of steering signal. Thus, system identification approach can be used in defining such an eye-steering system. Identifying a model with a good fit for normal (non-distracted) driving could be helpful in distraction detection: changes in model parameters or model fit variations could indicate a deviation from the normal state of a driver, i.e., distraction.

The system identification approach offers promising methods for identifying an eye-steering system (Table 4). System identification is a method to obtain the characteristics of a mathematical model of a system using experimental data and to create an input-output map (Ljung, 2009). Different parametric models that can describe a system in terms of differential equations and transfer functions could be generalized by linear polynomial model

$$A(q)y(t) = G(q)u(t) + H(q)e(t) \quad (1)$$

and

$$G(q) = \frac{B(q)}{F(q)} \quad \text{and} \quad H(q) = \frac{C(q)}{D(q)}$$

where  $u(t)$  and  $y(t)$  are the input and output of the system respectively;  $e(t)$  is zero-mean white noise, or the disturbance of the system.  $A(q)$ ,  $B(q)$ ,  $C(q)$ ,  $D(q)$ ,  $F(q)$  are polynomials that contain the time-shift operator  $q$ , and  $G(q)$  and  $H(q)$  are transfer functions of the deterministic and stochastic parts of the system respectively (Figure 3).

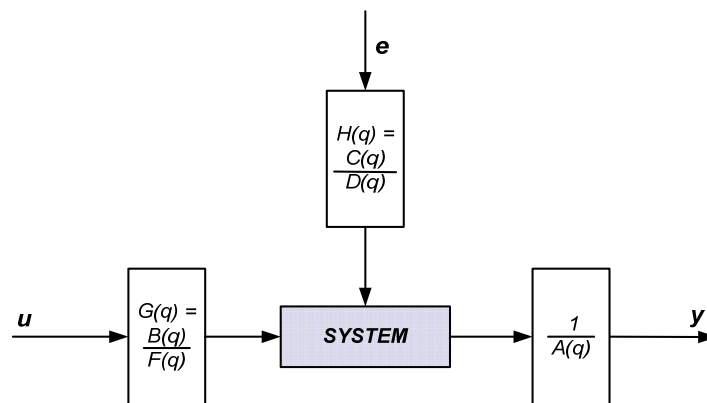

Figure 3. General linear model structure

To predict steering current value from its past values, autoregressive moving average (ARMA) and autoregressive integrated moving average (ARIMA) can be considered. When the observed time series is driven by some "forcing" signal (i.e., eye movements predict steering), ARX and ARMAX model structures with an "exogenous" variable should be considered.

Table 4. Summary of models' structure

Model structure	Polynomials	Description
AR: $A(q) y(t) = e(t)$ 	$B(q), C(q), D(q), \text{ and } F(q)=1$	This structure is for time series analyses. There are no inputs or disturbances in the model; current output dependent only on previous outputs.
ARMA: $A(q) y(t) = C(q)e(t)$ 	$B(q), D(q), \text{ and } F(q)=1$	This structure is for time series analyses. This model is for a single-output time series and modeled disturbances. There are no inputs.
ARX: $A(q) y(t) = B(q) u(t- n_k) + e(t)$ 	$C(q), D(q), \text{ and } F(q)=1$	This is the simplest model incorporating the stimulus signal. This structure is preferable for high order models. The disturbances are part of the system dynamics.
ARMAX: $A(q) y(t) = B(q)u(t- n_k) + C(q) e(t)$ 	$D(q), \text{ and } F(q)=1$	The structure includes modeled disturbance dynamics that makes models more flexible in handling disturbances than the ARX structure.

Table 4. Continued

Model structure	Polynomials	Description
Box-Jenkins (BJ): $y(t) = [B(q)/F(q)] u(t-n_k) + [C(q)/D(q)] e(t)$	$A(q)=1$	This structure models disturbance separate from system dynamics. The model is useful when disturbances enter late in the process.
		
OE (output-error): $y(t) = [B(q)/F(q)] u(t-n_k) + e(t)$	$A(q), C(q), D(q), \text{ and } F(q)=1$	This structure is common for dynamical systems. It is useful for dynamics parameterization, but not for noise estimation.
		

### ARIMA model

ARIMA model is made up of two parts: (1) the autoregressive (AR) that describes the dependence of the current time series value on the previous values; and (2) the moving average (MA), a weighted sum of the previous points of the noise series. The integrated part (I) of the model refers to the stationarity assumption. For the stationary time series data, the ARMA without the integrated part is

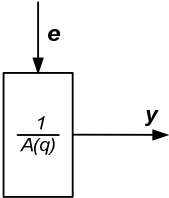
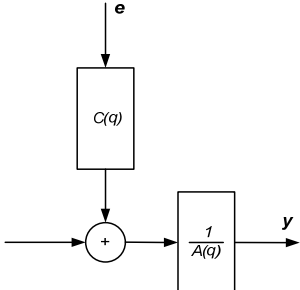
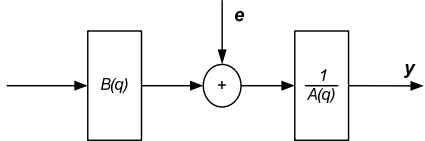
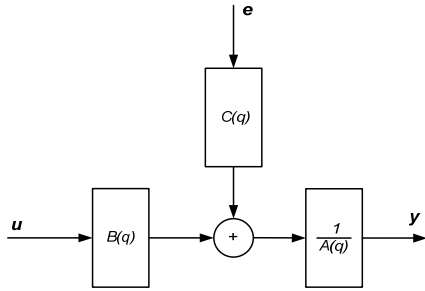
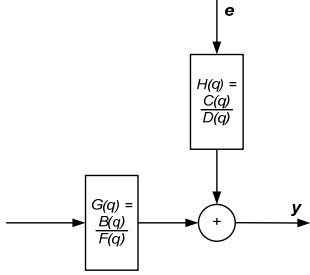
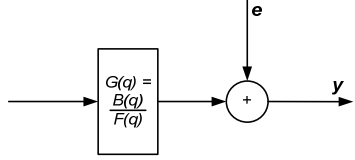
$$y_t = \underbrace{a_1 y_{t-1} \dots + a_p y_{t-p}}_{\text{AR model of } p \text{ order}} + e_t + \underbrace{b_1 e_{t-1} \dots + b_q e_{t-q}}_{\text{MA model of } q \text{ order}} \quad (2)$$

The ARIMA model is also named Box-Jenkins model after the statisticians Box G. and Jenkins G. who created it.

### ARX and ARMAX models

In the dynamic system the output (*endogenous* variable) can be described not only as a linear function of a current value of the input (*exogenous* variable) but also as a function of previous values of both the input and output measured at times  $t, t-1, t-2$ , etc.

$$\begin{aligned} y(t) + a_1y(t-1) + \dots + a_{n_a}y(t-n_a) \\ = b_1u(t-n_k) + \dots + b_{n_b}u(t-n_k-n_b+1) + e(t) \end{aligned} \quad (3)$$

where  $n_a$ , the number of previous outputs that affect the current output  $y(t)$ , and  $n_b$ , the number of previous inputs that affect the current output  $y(t)$ , are the orders of the model,  $n_k$  is the number of input samples that occur before the input affects the output (time delay or dead time), and  $e(t)$  is white-noise.

This is the simplest ARX, AutoRegressive (related to output) with eXogenous input, model. This input-output relationship is presented for the single input-single output model (SISO); it could be extended for a multiple input- single output (MISO) case. The symbolic representation of the ARX model is

$$A(q)y(t) = B(q)u(t-n_k) + e(t) \quad (4)$$

where  $q$  is the delay operator,  $A(q) = 1 + a_1q^{-1} + \dots + a_{n_a}q^{-n_a}$ , and

$$B(q) = 1 + b_1q^{-1} + \dots + b_{n_b}q^{-n_b+1}$$

The coefficient  $B(q)/A(q)$  is a transfer function that denotes the dynamic properties of the system, describing how the output is formed from the input. Disturbances at the output depend on noise source  $e(t)$ . The coefficient  $1/A(q)$  describes noise properties. Different sets of parameters of the mathematical model could describe different conditions of the system, e.g. distracted and non-distracted driving. This structure assumes that disturbances are part of the system dynamics and this type of model can be accepted when the disturbance of the system is white

noise. If disturbances are not part of the system dynamics, the ARMAX structure will provide more flexibility for noise modeling through an additional term  $(C(q)/A(q)) e(t)$  in equation (4). Noise reflects the known and unknown influences on measured output that are not captured by the input. It explains the differences in output with the same input. There are many sources and causes of these disturbances  $e(t)$ : measurement noise, uncontrollable environmental effects, etc. The system identification problem is to define the coefficients in equation (4).

### Process stationarity

These models are based on a steady state process (Ljung, 1987). The steady-state assumption implies invariance of several statistical properties of the signal, i.e., mean, variance, and autocorrelation do not change over the time of prediction. In general, time series can be represented as the following sum:

$$u(t) = \text{trend} + \text{cycles} + \text{stationary stochastic process}$$

where trend represents a general systematic linear or nonlinear component (i.e., mean) that changes over time; a cycles term relates to the seasonality and has a fixed frequency, phase, and amplitude; and stationary stochastic process is the part of time series that should be modeled (Gottman, 1981). The trend can be approximated by a linear function of  $u(t) = a + bt + e(t)$ , where  $e(t)$  is a white noise with a constant variance and mean. The data with the nonlinear component need to be transformed – logarithmic, exponential, or polynomial functions – to remove the nonlinearity associated with variance changes. The cycle of the time series can be fitted with periodic function.

As a rule of thumb, non-stationary data cannot be modeled or forecasted accurately with approaches that assume stationarity. The data needs to be transformed into stationary data. There are two alternatives to eliminate trend of non-stationary data: detrending and differencing. Detrending is the operation of

removing linear trend from the series by subtracting of the best-fit line from the data. Differencing transforms a time series by calculating the difference between two consecutive values of the series (Hartmann, Gottman et al., 1980).

Differencing operation can be applied  $n$  times to remove  $n^{\text{th}}$ -degree polynomial trend. Differencing does not remove the treatment effects (McCain and McCleary, 1979). This transformation simply gives a different representation of a time series model without affecting its parameters that represent intervention effect and describe systematic behavior of a model (Hartmann, Gottman et al., 1980). Thus, removing a trend from the data focuses the analysis on the fluctuations in the data about the trend, i.e. stochastic process.

The tests that evaluate statistical independence of data and underlying trends are “run test” and “reverse arrangement test” ensure the transformed data are stationary (Bendat and Piersol, 1986). The “run test” was applied to quantify the steadiness associated with the absence of a trend in baseline recordings of cardiovascular signals and to identify sub-periods of steady state during a sequence of physical activities (Castiglioni and Di Rienzo, 2004). The test was based on the runs defined as a sequence of identical observations coded by “+” or “-“. These symbols designate if the signal value is greater or less than the median value. The hypothesis that the signal does not have a trend is associated with the independency of observations: the number of consecutive “+” and “-“ is equal. The number of runs has a sampling distribution and this hypothesis can be tested at any desired level of (Bendat and Piersol, 1986). The mean and variance of the  $r$  (runs) distribution are  $Mean[r] = N/2 + 1$  and  $Var[r] = N(N - 2)/4(N - 1)$ .

Reverse arrangements test was performed on the lateral position data to check the signal stationarity (Pilutti and Ulsoy, 1999). This test was based on counting the number of times that  $x_i > x_j$  for  $i < j$ . The number of reverse arrangements is a random variable with  $Mean[ra] = N(N - 1)/4$  and  $Var[ra] =$

$N(2N + 5)(N - 1)/72$ . The total number of times (reversals) when the condition is satisfied for all  $x_i$ , when  $i = 1, 2, \dots, N$  will have a sampling distribution and can be tested at any desired level of significance (Bendat and Piersol, 1986). The reverse arrangement test is considered more powerful than the run test for detecting monotonic trends in a sequence of observations, but not for detecting fluctuating trends (Bendat and Piersol, 1986).

On the other hand, there is an indication that the runs test and reverse arrangements test are not always accurate tests for signal stationarity (Becka, Housha et al., 2006). This finding may reflect the fact that these tests were designed to determine whether or not a signal is random, rather than to ensure the signal is stationarity (Siegel and Castellan, 1988).

A monotonic time series can be detected by plotting the data as a function of time and adding the best-fit line (Chambers, Cleveland et al., 1983). The nonzero slope of the best-fit line would be an indicator of a trend in the data. Another indication of the existence of linear or non-linear trend in the data is a nonzero value in a spectral density function at zero frequency (Gottman, 1981, p.47). Plotting the autocorrelation function as a function of lag can also reveal the presence of a trend in data: without trend, it will decay to zero much more rapidly than a linearly decreasing function. The detection of cycles in time series could be also done through the spectral and autocorrelation analyses: it will be the presence of thin spikes in the spectral density function and cycles in autocorrelation function.

Thus, for the eye-steering system identification using a black box modeling approach, the non-stationary data should be transformed into the trend-stationary ones. Information about trend and cycle in the time series is important and should be modeled before removal. Assuming that the segments with only one type of glance, i.e., on-road or off-road, is stationary, then the segments with two or more



types of glances could cause changes in trend or cycle. The changes in autocorrelation function associated with glance pattern changes might be indicative of driver state, i.e., presence of distraction.

#### Driver state assessment through system identification

Efforts in developing a mathematical model of human control performance in driving are based on the data from compensatory tracking tasks: subjects control a random input signal with the control devices (e.g., accelerator and steering wheel) to obtain a desired output (Smiley, Reid et al., 1980). The input-output system error (i.e., difference between the output and the input) prompts a driver to initiate a control and use it as a system input. For example, visual information from the driving scene could be used as a prompt of changes in vehicle state and the associated corrective steering movements. The interruptions in error tracking might lead to breakdowns in system performance. Thus, such models could trace changes in operator performance or behavior.

The following examples demonstrate the attempts of modeling system dynamics based on stationary signals to define driver state. A system identification approach was used to develop a model for driver state assessment with vehicle lateral position as an input and steering wheel position as an output (Pilutti and Ulsoy, 1999). A preliminary second order ARX model was created from desktop driving simulator data. It was shown that changes in the bandwidth and parameters (i.e., damping ratio, natural frequency, and gain) of such a model may indicate changes in driver state, i.e., normal driving vs. fatigued driving. The defined identification algorithm was applied to data from two-hour highway driving conducted in a full-vehicle driving simulator. The model parameters did not exhibit the trends expected as lane keeping performance deteriorates. Several reasons of not detecting driver impairment were: (1) the selected model structure

was not the most appropriate; (2) the existence of nonlinear effects associated with a complacency zone when steering position remains constant while lane deviation errors build; (3) the choice of the low order model structure did not result in a good fit; and (4) the variations in parameters could cause poor differentiation between driver states. The last three reasons relate to model uncertainty.

An estimated model is always uncertain due to disturbances in the observed data and the lack of an absolutely correct model structure. Two types of uncertainty were considered in modeling lateral position through steering angle with a linear ARMAX structure: structured uncertainty related to the model parameters and unstructured uncertainty related to unmodeled dynamics (Chen and Ulsoy, 2001). In this study, the structured uncertainty was considered to represent the variation of driver behavior with time and the unstructured uncertainty was considered to represent model order and nonlinearity. It has been shown that the model order and nonlinearity associated with a complacency zone did not contribute to the unstructured uncertainty, but the variability in driver's steering behavior may be the primary source of the large uncertainty.

These two studies showed that the system identification approach could be used to detect driver impairment based on model parameters changes. Different model structures and orders should be examined for their best fit. Nonlinear relationship between input and output should be considered as a possible unstructured uncertainty when there is an intervention effect, i.e. changes in driver state caused by distracting activity. The changes in model fit could indicate changes in driver state, i.e., distraction.

#### Gaps in literature and proposed work

Previous research has demonstrated visual behavior (i.e., glance pattern) and driving performance (e.g., steering and lane keeping) reveals distraction. The

prototypes and existing algorithms for distraction detection are mostly based on either eye measures or driver performance measures (e.g., speed, lane position, and steering). These algorithms are intended to provide concurrent and retrospective feedback, but a prospective indicator of distraction has yet to be considered.

The relationship between eye and driving performance metrics in the context of driver distraction has not been established. However, previous research considering control theoretic models of driver steering behavior suggest changes in the coordination between these metrics can indicate distraction and predict breakdowns in lane keeping. This consideration can also improve the sensitivity of the algorithm by differentiating the type of impairment (drowsiness vs. distraction) and robustness of the algorithm.

A relationship between driver visual behavior and vehicle control is expected because of observed eye-body coordination that is highly consistent in everyday activities – eye movements precede motor actions (Hollands, Zivara et al., 2004). This coordination is very specific for different activities. The eye-steering coordination – Land’s visual information framework – was observed in driving on open curvy roads (Land and Furneaux, 1997). The alternative (or additional) approach explains eye-steering movements through the oculomotor controller concept – movement centered framework (Wilson, Chattington et al., 2008). This concept assumes that some neural centers produce and control eye movements and then assist the neural centers that control steering. Visual information intermittency in movement control assumes intermittent corrections – when each sub-movement is planned to reduce error developed in the previous step (Miall, Weir et al., 1988). These different concepts assume that the visual behavior and vehicle control relationship is strong enough to make a prediction about driver performance; different mechanisms can be responsible for this relationship.

Based on these findings, the prediction of steering behavior could be done through the eye movements with the oculomotor controller as a transfer function. This prediction could be very valuable in crash risk assessment because changes in steering lead to changes in lane position with taking into account vehicle dynamics (Figure 4). This sequential *eye movement – steering – lane position* behavioral model defined for non-distracted driving could predict large deviations from the centerline caused by visual distraction and falsely seeming improved driving performance associated with cognitive distraction. In all the cases, the changes in driver performance could be caused by changes in eye-steering coordination that, in turn, could indicate driver state changes.

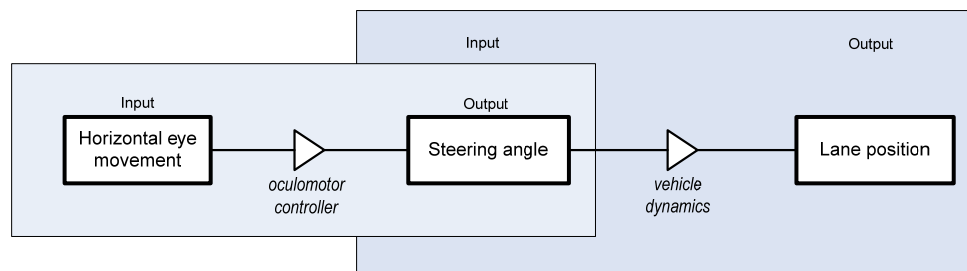

Figure 4. Eye movement – steering – lane position relationship

Driving performance is impaired when eyes remained fixed or when eye movements are limited by either a restricted field of view (Wilson, Stephenson et al., 2007) or by high a stress condition (Wilson, Chattington et al., 2008). These eye movement impairments caused steering control disruption. The eye-steering coordination measured through the cross-correlation coefficient decreased while driving on curvy roads. Another measure affected by the impairment was time delay between eye and steering movements. The average time interval by which eye movements preceded steering decreased with diminished coordination. This

outcome was observed with alcohol impairment when the optimal eye-steering relationship deteriorates with the alcohol level (Marple-Horvat, Cooper et al., 2008). An intervention effect of impaired condition (high stress) on driver performance (task completion time) was mediated by eye-steering coordination (Wilson, Chattington et al., 2008).

These findings suggest: (1) high degree of eye-steering correlation on open curvy roads; (2) decrease in this coordination caused by impairment; and (3) a relationship between the degree of eye-steering coordination and driver performance measured through task completion time. The following research questions are still not answered:

- What is the degree of eye-steering coordination on straight roads?
- Does secondary task performance affect eye-steering coordination?
- Does the eye-steering coordination mediate the effect of driver impairment on driver performance measured through vehicle position in the lane?

I propose that (1) eye-steering relationship measured through the cross-correlation coefficient and time delay between two signals will depend on type of eye movements, e.g., eye movements guide steering, eye scan road ahead, and eye move away from the road scene; (2) it is possible to model a steering wheel position as a function of its previous values and eye movement signal. This system can distinguish between distracted and non-distracted driving; (3) eye-steering correlation changes can predict driver performance degradation. As a prospective indicator, it can mitigate and prevent crash risk caused by distraction. Here, the crash risk is associated with relatively large deviations from the centerline that can impact safety (Figure 5).

To address these specific goals of my research, three distinct aims were addressed:

Aim 1: The effect of distraction on eye and steering movements and on the relationship between them is assessed through the interrupted time series and correlation analyses.

Aim 2: The black box approach is applied for parametric eye-steering system identification.

Aim 3: The eye–steering correlation parameters are examined to assess whether they act as a mediator or moderator in the *distracted condition – driver performance* (i.e., lane position) relationship. The ability of the correlation parameter (correlation coefficient and time delay) to mediate the effect of distraction on lane position supports the assumption that it could act as prospective indicator of lane keeping performance to predict lane departures.

These three aims will allow: (1) distraction detection based on changes in correlation between eye movements and steering; (2) eye-steering model design to identify driver distracted condition through changes in model fit; and (3) examination if changes in eye-steering coordination can predict driver performance degradation.

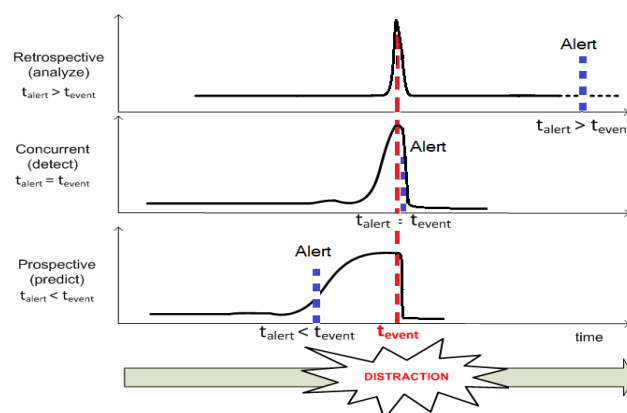

Figure 5. Comparison of the different timelines for distraction indication. Time of event is associated with the time of maximum risk of crash caused by distraction

### CHAPTER 3. MEASURE OF CHANGES IN EYE AND STEERING MOVEMENTS CAUSED BY DISTRACTION

To examine the changes in eye and steering signals caused by distracting activity, the interrupted time series analysis using a segmented regression modeling is conducted. The interrupted time series analysis examines changes in two segments of data: before and after intervention, which is associated with non-distracted and distracted states of a driver respectively. A correlation analysis assesses the relationship within and between eye and steering signals for each of these segments of data. The auto- and cross- correlation functions are calculated for different types of eye movement associated with non-distracted and distracted driving.

#### Analysis method

##### Interrupted time series analysis

Interrupted time series analysis is a statistical method for analyzing how an intervention affects a subsequent series of observations, i.e. time series. For instance, an intervention effect of a distracting activity on eye and steering movements can be examined through the interrupted time series analysis by comparing two segments of data collected before and after the intervention, i.e., before involvement in distracting activity and during distracted driving (Gottman, 1981).

An advantage of time series analysis is that it could be applied when the observations are serially dependent and when the experimental effect is small (Hartmann, Gottman et al., 1980). Serial dependency refers to the cases when temporally ordered behavioral measurements for a single subject cannot be considered as independent observations and the performance of the subject at a

given moment can be predicted from the performance at the earlier points, e.g., time series of the steering wheel angle depends on its previous positions.

Two parameters can define the intervention effect on time series: the level that is the value of the series at the beginning of each segment and trend that is the slope (rate of change) of a signal within each segment (Figure 6). A change in level, e.g. a jump or drop in the outcome, and change in a slope of the segment could designate an intervention effect (Gottman, 1981). The intervention components in interrupted time series are referred to as transfer functions. These functions relate to either the level or the slope of the series from one state (pre-intervention period) to another state (post-intervention period) (Hartmann, Gottman et al., 1980).

Segmented regression model that fits to each segment estimates the level and slope for the pre-intervention and post-intervention segments (Wagner, Soumerai et al., 2002):

$$Y_t = b_0 + b_1 * t + b_2 * intervention_t + b_3 * time\ after\ intervention_t + e_t \quad (5)$$

where  $Y_t$  is the outcome at time  $t$  from the start of the observation period;  $intervention_t$  indicates the presence of intervention at a time  $t$  and coded as 1, otherwise 0; and  $time\ after\ intervention_t$  is a variable that counts time after the intervention. The latter variable is coded as zero before the intervention and calculated as  $(t - intervention\ onset)$  after intervention.

In this model,  $b_0$  estimates the level of the outcome at the beginning of the pre-intervention period;  $b_1$  estimates the rate of change in the outcome before the intervention (i.e., the baseline trend);  $b_2$  estimates the level change in outcome immediately after the intervention; and  $b_3$  estimates the change in the outcome trend after the intervention, as compared with the period before the intervention.

The sum of  $b_1$  and  $b_3$  is the post-intervention slope. In this model, the estimation of



the level and trend changes associated with the intervention is done in the comparison with the baseline level and trend. The error term  $e_t$  at time  $t$  represents the random variability not explained by the model. The estimated model parameters are tested (i.e., t-test) to determine if there is a statistical significance between obtained values.

In driving, shifts from on-road to off-road glances (scanning road ahead vs. secondary task performance) could cause changes in the eye position and steering angle time series. The segmented regression analysis can assess the changes in time series: abrupt vs. gradual, persistent vs. temporary, and delayed vs. immediate (Wagner, Soumerai et al., 2002). Plotting the regression models of both segments will visualize the dynamics of the outcome response to the intervention (Figure 6). The parameter of interest in this study is trend in the steering angle rate and horizontal eye position. It is assumed that the level of steering angle would be unchanged because with off road glances, the probability of steering to the left and to the right is same on straight roads.

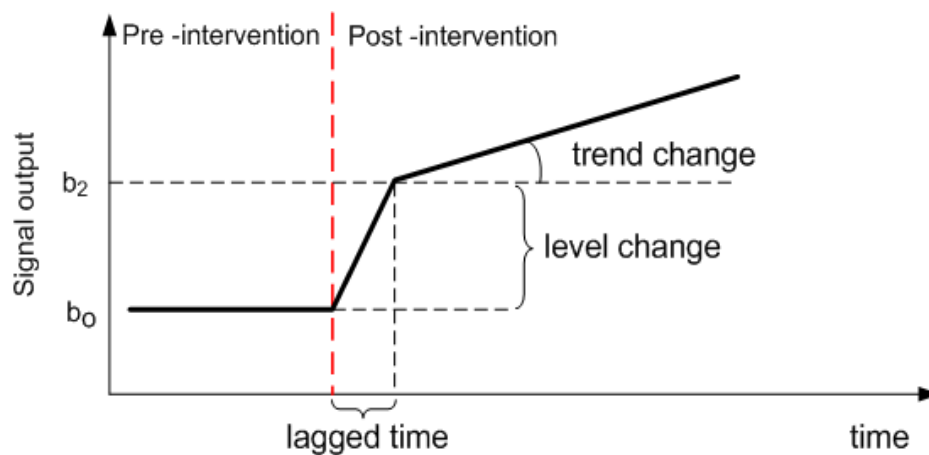

Figure 6. The effect of intervention (e.g., distraction) on time series: changes in a level and in a trend

### Correlation analysis

The interrupted time series analysis examines changes in two segments of time series, before and after intervention through modeling the trend changes associated with each segment. The correlation analysis assesses the relationship between measures within each segment of data (autocorrelation) and the relationship between two signals (cross-correlation). The degree to which two signals, e.g. steering and eye movements, are correlated could be estimated in time domain through cross-correlation analysis (Beauchamp, 1973; Juang, 1994). A measure of signal correlation with itself – autocorrelation – shows association between observations as a function of the time separation between them (time lag). This can reveal not only randomness or periodicity of the signal but also the dependency of the current measure from the previous values to identify an appropriate time series model. For a given signal  $y$  with the time-lag  $k$  autocorrelation function is

$$R(k) = \frac{\sum_{i=1}^{N-k} [(y(i) - \mu_y)(y(i+k) - \mu_y)]}{\sum_{i=1}^N (y(i) - \mu_y)^2} \quad (6)$$

For a random process (white noise), autocorrelation function is near zero (inside the confidence interval) for all time lags. For non-random processes, autocorrelation coefficient for some time lags is outside the confidence interval. For periodic processes, the autocorrelation function shows signs of periodicity (Figure 7).

Cross-correlation analysis is used to compare two signals and measure the similarity between them as a function of a time lag applied to one of them. The cross-correlation function  $R_{uy}(k)$  between values of input and output signals as a function of the time difference ( $k$  delay) is defined as

$$R_{uy}(k) = \frac{\sum_{i=1}^{N-k} [(u(i) - \mu_u) * (y(i+k) - \mu_y)]}{\sum_{i=1}^N \sqrt{(u(i) - \mu_u)^2} * \sum_{i=1}^N \sqrt{(y(i) - \mu_y)^2}} \quad (7)$$

where  $u$  is an input,  $y$  is an output,  $\mu_u$  and  $\mu_y$  are mean values of the input and output signals,  $k$  is a time delay, and  $N$  is a number of delayed intervals.

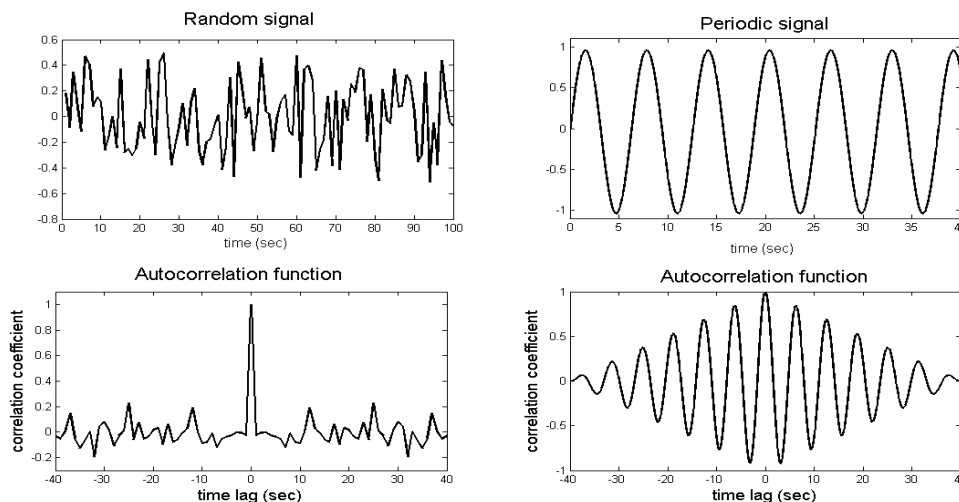

Figure 7. Autocorrelation functions for random and periodic signals

The cross-correlogram represents calculated cross-correlation coefficient for different time delays. It assesses the overall relationship between two signals that could be considered as a system input and output. The peaks of the cross-correlogram show the degree and relative timing of any covariation between the input and lagged output signals (Figure 8).

This analysis could be helpful in model definition: the current output value will most likely be defined through the input values shifted by time delay defined through the peaks of cross-correlation coefficient. The higher the absolute value of cross-correlation coefficient the stronger the coordination between input and output is. The value of  $100 * R_{uy}^2$  shows the percentage of variance in the output

signal that is attributable to covariation with the input signal. In other words, it measures the output percent that can be explained by varying the output with input.

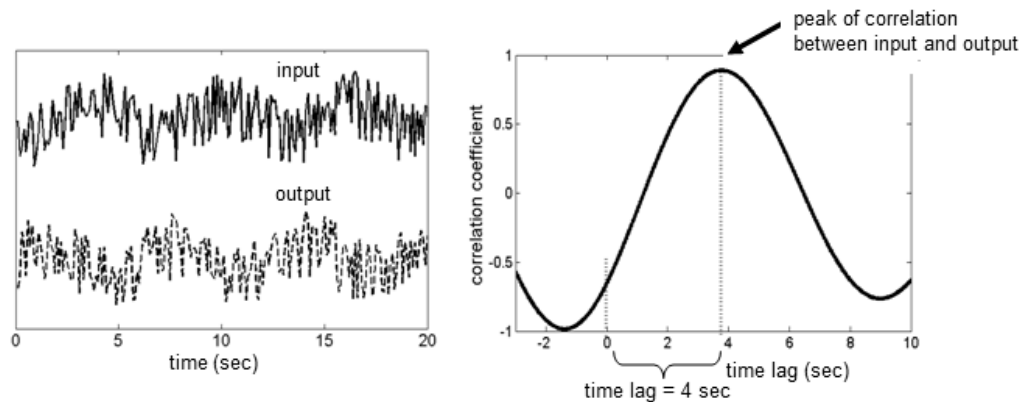

Figure 8. Cross-correlogram with one peak calculated for two signals with the cross correlation showing a strong association between them: one signal is lagged relative to the other one by 4 sec (time delay)

#### Eye-steering correlation for eye movement types

An important issue to examine is the changes in the magnitude of the eye-steering correlation and reasons for these changes.

Winding roads place a greater demand on the driver's eyes to follow approaching curves (Wilson, Chattington et al., 2008). Strong eye-steering coordination arises on curvy roads when there is a need of a visual guidance for steering movements: drivers search for a glance location and fixation to steer while approaching a bend (Land & Furneaux, 1997). These horizontal eye movements between road center and bend tangent point are associated with steering control.

While driving on a straight road, drivers scan the road ahead to be aware of the driving situation and less frequently to guide their steering. This scanning behavior is likely to be weakly correlated with steering (Figure 9, a) because the “forcing” input is not strong enough to generate an appropriate output, i.e. there

are no reasons for coordinated eye and steering movements. Thus, a low correlation between eye position and steering may not always designate driver impaired condition as it was shown in the studies of Wilson et al. (2008) and Marple-Horvat et al. (2008).

Eye movements associated with visual distraction (glances away from the road and back to the road) have a qualitatively different relationship to steering. Glances away from the road might be associated with visual information loss that diminishes steering output. Glances back to the road cause subsequent steering movements that are needed to correct vehicle state in the lane. Because of this eye-steering coupling, the correlation might be relatively large (Figure 9, b); but this correlation will differ fundamentally from coordination while approaching the bend when eye movements guide steering in a smooth consistent way. Another expected difference is a relatively large correlation with the absolute value of the steering wheel position with glances away from the road, but the correlation with visually guided steering would be associated with the direction. The large amplitude periodic visual and steering movements provoked by shifts from off-road to on-road glances will be associated with lapses in a vehicle control and can designate visual distraction.

Cognitive distraction will likely affect the relationship between eye and steering movements differently than visual distraction. Cognitive distraction lead to eye movements concentrated in the center of the road (Figure 9, c) and it will most likely reduce the association between eye and steering wheel positions. This eye-steering pattern will be associated with diminished attention to the road environment caused by cognitive distraction.

In this study, the relationship between eye and steering movements are tested for four types of eye movements: (1) scanning road ahead designating non-distracted driving; (2) shifts of glances between on-road and off-road areas

designating visual distraction; (3) reduced eye movement: glances concentrated in the road center designating cognitive distraction; and (4) glances concentrated in the road center combined with single glances away from the road. This type of distraction will be classified as combined cognitive/visual distraction and can be associated with the situation when a cognitively distracted driver shifts eyes to the in-vehicle system or control panel.

a) Non-distracted driving

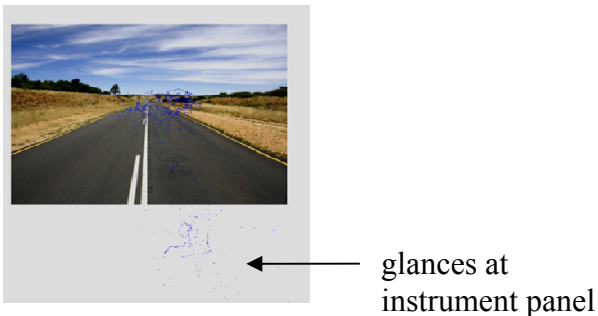

b) Visually distracted driving

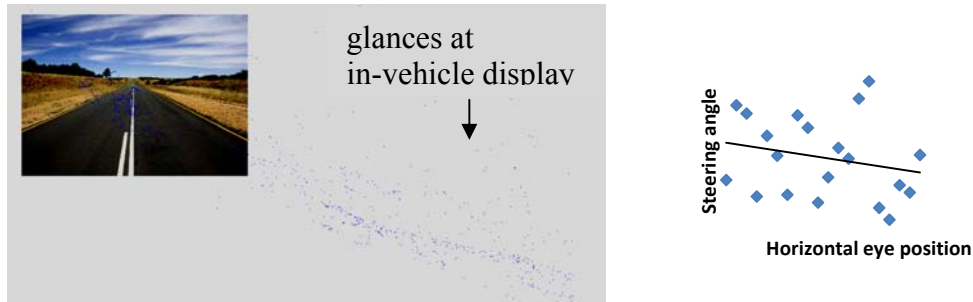

c) Cognitively distracted driving



Figure 9. Glance locations and hypothetical scatter plots of associated horizontal eye position and steering wheel angle for non-distracted and distracted driving on a straight road

## Data collection and processing

### Experimental data

For the analysis, data from a simulator study (Liang, 2009) is used. Eye movement and steering movement (steering angle) signals from 16 participants (8 male and 8 female) between 35 to 55 years old were collected while the participants drove on a straight, five-lane suburban arterial roadway comprised of two lanes in each direction separated by a center turning lane. Participants performed 8-minute drives for each non-distracted (baseline) and distracted (visual/manual, cognitive, and combined cognitive/visual tasks) condition. This 8-minute simulator driving included pre-task (first minute) and post-task (last minute) segments. The order in which participants received these tasks was counterbalanced.

For the visual/manual task, the participants were instructed to match the direction of a given arrow within a 4x4 arrow matrix using a seven-inch LCD touch-screen interface (Figure 10) located on the right side of the dash 25 degrees laterally and 20 degrees vertically below drivers' line of sight.

For cognitive task, the participants listened to an audio clip and identified which direction (e.g., east, north, and southwest) people faced based on the clip. The participants were instructed to speak out loud the direction as soon as possible after hearing each turn and to press a button on the steering wheel at the same time. The task required auditory input, verbal and manual output, and spatial working memory.

For the combined cognitive/visual task, the participants listened to audio clips similar to those in the cognitive task and selected the orientation using the interface similar to the visual task. The timing of the three tasks was the same: the participants had five seconds to respond. If they responded in less than five

seconds, another task would follow immediately. Otherwise, the next task would begin after five seconds. In this way, the participants were constantly distracted by the secondary tasks during the six-minute task period.

Participants were instructed to drive at 45 mph (72kph). The vehicle was equipped with a simulated cruise control system to ensure that the participants maintained a constant velocity. The cruise control was automatically activated when the vehicle reached 45 mph (72 kph) and deactivated by pressing the brake. Participants were encouraged to use the cruise control system as much as possible. Braking events were used periodically requiring driver response when the lead vehicle slowed down. Steering movement signal was enriched by additional continuous external disturbance that forced the vehicle toward the lane boundary requiring participants to remain vigilant to the lateral position of the vehicle.

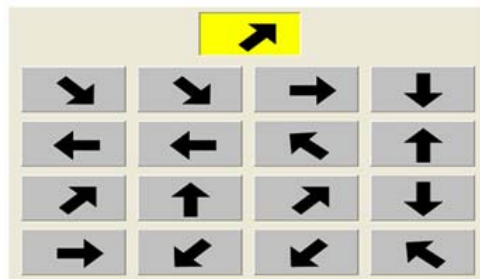

Figure 10. In-vehicle display of the visual-manual arrow matching task (Liang, 2009)

Both a faceLab<sup>TM</sup> eye tracking system by Seeing Machines (version 4.1) and the simulator collected data at 60 Hz. The eye tracking system is a two-camera system mounted on the dashboard that provides fully automated head and eye tracking. The advantage of the system is an ability to work with all eye types, in light and dark environments, and with subjects wearing sunglasses, contact lenses,



and most eyeglasses. The main advantage is non-intrusiveness. Alternative eye tracking systems – head mounted systems – have better accuracy but potentially interfere with driving and cannot be implemented for everyday eye tracking on roads.

#### Data pre-treatment

As a first data-preprocessing step, the data from each 8-minute simulator driving session were reduced to 6 minutes by removing first (pre-task) and last (post-task) minutes from each dataset. For the eye-steering system identification and correlation analysis, several issues such as presence of outliers, glance type identification, segment size, and sampling rate are considered.

The presence of outliers can have a disproportionate effect on the results of correlation analysis and model definition. To check the quality of data, the eye movements from each driving session are plotted to determine unusual data points. Along with visualization, the calibrated data, when eye position was matched to the screen dimensions through scaling and offsetting, is tested for a tracking quality using eye tracker code. The outliers are defined through the rate of eye position changes: the data points are classified as outliers – sharp spikes – if the rate of eye movement exceeds the threshold value. According to the three-sigma rule, the rate of eye movement that exceeds three standard deviations defined for each subject is used as a threshold (Maronna, Martin et al., 2006). These bursts can be caused by eye tracker failures to detect an eye movement or saccade movements.

The sets of data points classified as outliers were interpolated when the length of a segment did not exceed 400 ms (i.e., 25 data points). Since, the most common range of fixation is between 200 and 400 ms (Salvucci and Goldberg, 2000), the segments up to 400ms can be interpolated without significant distortion

of eye movement information. Otherwise, the segments were deleted. An example of the preprocessed signal is presented on Figure 11. Some spikes remained after preprocessing might indicate high-frequency eye movements, e.g., saccades or quick glances at relatively far locations.

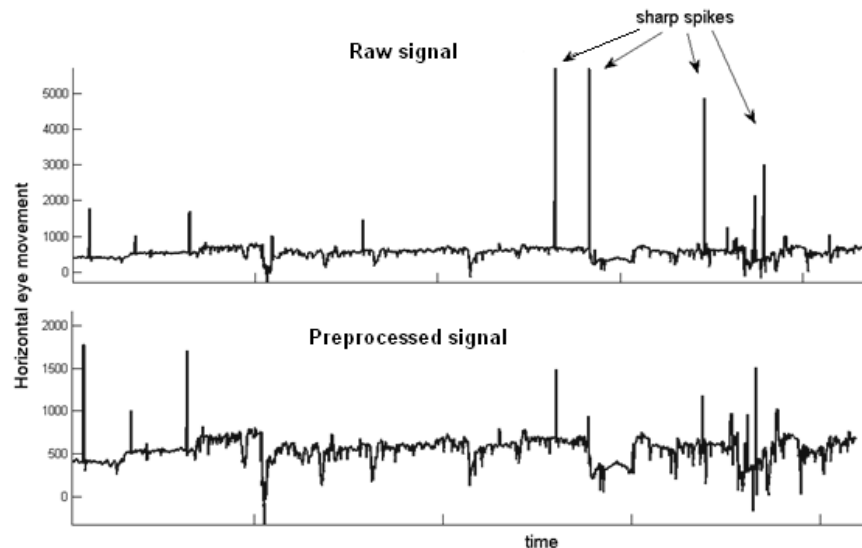

Figure 11. Horizontal eye position before and after outliers' identification and segments' interpolation. Sharp spikes are associated with outliers

The data pre-processing removed artifacts and assured that the datasets accurately represent driver visual behavior in different distracted conditions. The basic criteria for reduction are that (1) data points fall unreasonably far from the locations associated with the task performance; (2) rate of eye movement exceeds the threshold defined for each driver; and (3) eye position data is distributed in a very unusual way (Figure 12, b).

Based on these criteria, the process of reduction is not consistent across the drivers. The minimum reduction length was 0.1 sec and maximum – 165 sec. On average, the 6-minute segments decreased by 50 seconds. The post-reduction data

plots showed that the outliers' exclusion reduced the number of "unexpected" glances for the most of the drivers (Figure 12, a) but not for subjects 3, 6, 12, and 16 (Figure 12, b). Thus, the data from these drivers were not considered in this study and the number of subjects became 12.

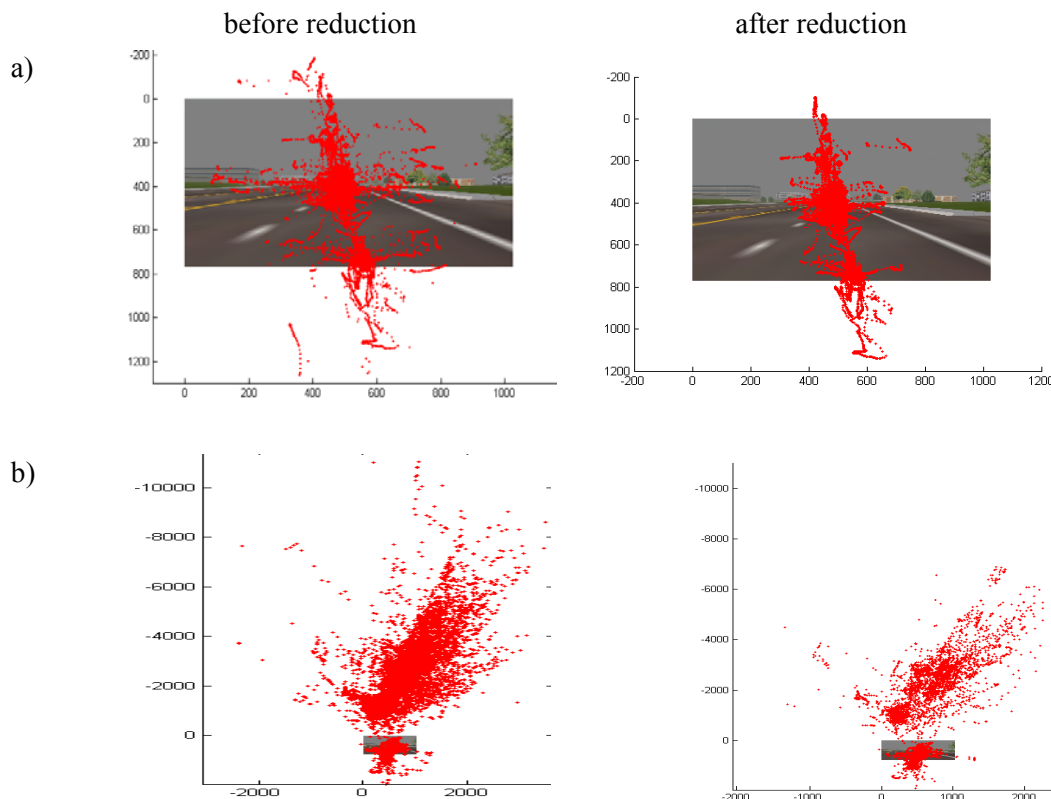

Figure 12. Examples of glance locations before and after exclusion of outliers

Steering and eye movement behavior can vary during a driving session and across drivers (Chen and Ulsoy, 2001). To examine these changes, different types of eye movement based on glance location were identified. Two basic types of glances are on-road and off-road. These two types are sub-segmented according to expected locations: near to the road center, far from road center, at driving scene but out of road, at the instrument panel, and at in-vehicle display (the classification

process is presented below). The glances at the locations that are not expected for a driving task are classified as unusual.

The overall process of signal preprocessing is on Figure 13. The definition of eye movement type through the glance classification is presented in the next section.

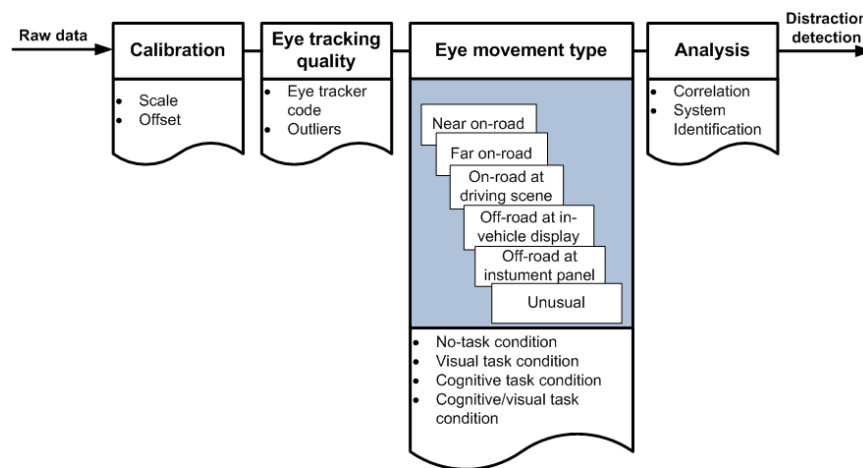

Figure 13. Data preprocessing flow chart

### Glance classification

Different types of eye movements are based on combination of two general types of glances: on-road and off-road (Figure 14).

The expected glance locations for non-distracted driving associated with road scanning are near the road center and far from the road center (far on-road) areas. The glances that fell on the screen but out of road area could be associated with the events and objects on the road, e.g., approaching intersection, pedestrians, and bicyclist. Reduced eye movements, with more near on-road glances, is expected for cognitively distracted driving.

The off-road glances to the in-vehicle display area are associated with visual task performance. Because this study was performed in a driving simulator without rear and side mirrors and with cruise control system, it is expected that the participants did not keep their attention on the instrument panel for speed maintenance and at mirrors for the environment scanning and the glances at these locations should be absent. However, the visualization of the glances through scatter plots revealed some glances concentrated at the instrument panel area. The glances that are not related to driving (unusual) glances are considered as a separate type (Figure 14).

The glances typical for non-distracted driving, on-road glances, are defined as the most frequent fixations at the road center and located in a small (near on-road) rectangular area of 20x15 degree centered around the road center point (Victor, Harbluk et al., 2005; Ahlstrom, Kircher et al., 2009). The expanded rectangular area with the same center point defines the eye fixations on the road (far from the road center on-road glances). The center point of the on-road glances, as mode values of horizontal and vertical eye positions, is calculated by binning the data in equal (i.e., 128 x 128) bins for a portion of the data in the forward view. The ratio of the small rectangular area and the whole field of view area is the same as it was in the study of Victor et al. (2005). The center of this area is defined for each driving session. Thus, near on-road glances fall within the rectangular area of 150x115 pixels (equivalent to 20x15 degree); far on-road glances fall outside this area and bounded by expanded rectangular area of 614x460 pixels (equivalent to 80x60 degree).

The off-road glances associated with the visual task performance are directed toward in-vehicle display. The center of in-vehicle display area is defined for visually and cognitively/visually distracted driving in the same manner: it reflects the most frequent fixations at the right side below the road center area. The

size of the in-vehicle display with the total resolution of 640x480 pixels is taken into account; it resulted in rectangular area of 85x63 degrees.

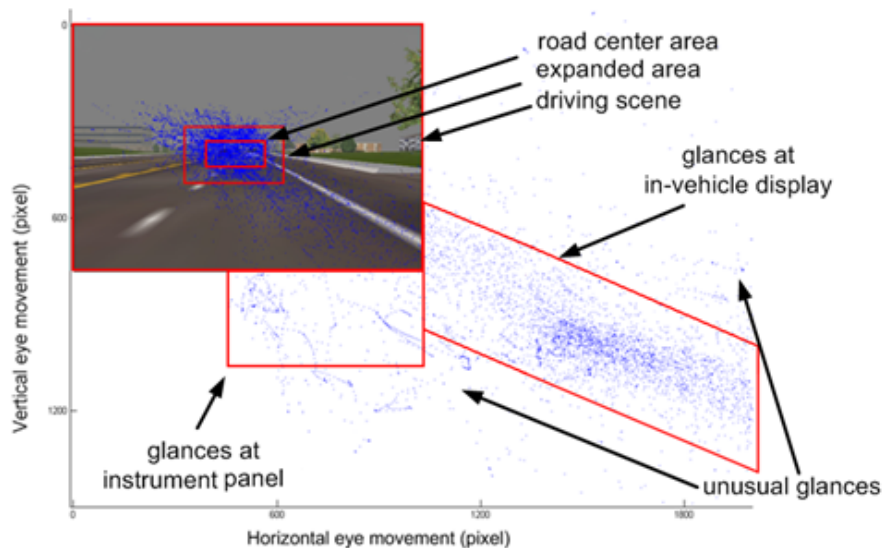

Figure 14. Classification of glances

This data reduction process considers different combinations of glance types to distinguish the segments with different eye movements (Table 5). For baseline condition, four types of eye movements are defined: at the road center (eye movement 2), at driving scene (eye movement 3); segments with glances at instrument panel (the combination of eye movement 3 and 4); and segments with glances unusual for driving task glances (the combination of eye movement 3 and 6). For distracted conditions, the glance patterns are similar during the driving session and across drivers. In general, eye movements 1 and 2 represent the cognitive task; the combination of eye movement 3 and 5 represent the visual task; and the combination of 2 and 5 eye movements represent the cognitive/visual task.

It is assumed that these eye movements characterize visual behavior associated with task performance.

This classification is mostly intended to reveal differences in eye movements during baseline driving for a single driver and across drivers. The consideration of the differences in eye movements during baseline drive is important for eye-steering model development: different types of eye movement can lead to different model parameters and variability in model fit.

Table 5. Combination of different types of glances to define an eye movement typical for different types of distraction

Eye movement	Glance type					
	on-road			off-road		
	near to the road center	far from the road center	at driving scene	at instrument panel	at in-vehicle display	unusual
1	√					
2	√	√				
3	√	√	√			
4				√		
5					√	
6						√

### Signal length and sampling

The accuracy of correlation analysis depends on the number samples, i.e. signal length and sampling rate. The choice of a sampling rate is based on the spectral analysis (Figure 21). For both states, the signals consist of very low frequency – less than 1Hz – meaning that both signals could be re-sampled to lower frequencies. However, in this study, the initial sampling rate of 60Hz is kept unchanged. There are two reasons for this. First, relatively high sampling rate provides timing accuracy, i.e., more precise estimation of time delay between eye

and steering movements. Second, because the previous studies that examined the eye and steering movements considered high-frequency signals of 200 Hz (Chattington, Wilson et al., 2007; Marple-Horvat, Cooper et al., 2008), the sampling rate is not reduced.

The choice of segment size is based on the assumption that it should be long enough to capture several glances. For instance, the segments of 30 seconds include at least ten glances because the single glance duration rarely exceeds three seconds (Liang, 2009). On the other hand, the segment length should be short enough to have relatively small variability, i.e., to represent a steady-state process. Stationarity assumption is an important issue in the system identification procedure. Here, the stationarity is closely related to the eye movement type. The segments where glances are slightly deviate from the road center are expected to be stationary. The presence of glances with large deviation from the road center, i.e., off-road, can make the data non-stationary. Therefore, examining different segments for the presence of a trend can reveal the non-stationary properties of a signal and help to define an appropriate eye-steering model.

The fundamental frequency concept can be used to define an appropriate length of a segment: this value will define the length of a cycle associated with glance shifts between on-road and off-road areas (Beauchamp, 1973). Based on the spectrum analysis (see Figure 21), the fundamental frequencies of horizontal eye position and in steering angle are low for non-distracted driving and, therefore, the cycle length is too long to consider that the signal is periodic (Table 6). The fundamental frequency increases (the cycle length decreases) with visually distracted driving meaning that the signal gets more signs of periodicity (shifts between on-road and off-road areas). The signal length for the correlation analysis should contain a number of cycles of the fundamental frequency component, e.g., five (Beauchamp, 1973). Thus, an adequate signal length of 30 seconds is



considered. To keep the consistency, the same length of a signal is used for non-distracted driving.

If the total number of observations is  $N$ , then the autocorrelation is typically calculated for the first  $N/4$  lags in the data set because higher order autocorrelations become increasingly unstable (Hartmann, Gottman et al., 1980). Thus, the autocorrelation functions for eye and steering signals are calculated for the first 8-second lags considering 30-second segments of data.

Table 6. Fundamental frequencies and cycle length for eye and steering movement signals

	No distraction		Visual distraction	
	Horizontal eye position	Steering angle	Horizontal eye position	Steering angle
Fundamental frequency (Hz)	0.026	0.069	0.259	0.175
Cycle length (sec)	38	14	4	6
Signal length for the analysis (sec)	189	72	19	29

### Results and discussion

The segmented regression and correlation analysis was conducted to study the intervention effect of distraction (visual, cognitive, and cognitive/visual tasks) on eye and steering time series and correlation between them. The expectation of this analysis is that the intervention effect of distraction will interrupt horizontal eye position time series causing changes in a slope (rate of a signal) and a level (mean value) and steering angle time series causing changes in a slope. The eye-steering correlation coefficient will vary with distraction type that is associated with presence of off-road glances: it will be low for non-distracted and cognitively

distracted driving and might slightly increase with visual and cognitive/visual distraction. This increase will be caused by coupling the glances back to the road with corrective steering movements to recover lane position errors built while looking off the road.

The results of these analyses are important for the eye-steering system modeling. The presence of a trend in time series is closely related to the signal stationarity, particularly the stationarity of mean. For model identification, the time series should be stationary. This requires detrending the signals and, thus, the trends should be modeled separately. The performance of the system built for one condition (i.e., baseline) will change with using signals from another conditions (i.e., distracted). It is important to define if these changes are caused by trend variations or by changes in correlation statistics. Interrupted series analysis and correlation analysis can elicit this information that will be used for eye-steering system performance evaluation – Aim 2 of this study.

#### Interrupted eye and steering time series analysis

Interrupted time series analysis was performed for two consecutive 30-second segments of non-distracted and distracted driving (visual, cognitive, and cognitive/visual task conditions). Pre-treated data from 12 subjects was used (see *Data pre-treatment* section). For non-distracted condition (pre-intervention segment), segments of pre-task condition and, for distracted condition (post-intervention segment), segments of task condition are used. The trend lines fitting and statistical analysis are performed in Matlab (R2010a) with Statistics Toolbox Software (version 7.3). The calculated values of level and slope for each type of segment are tested for being statistically significant from zero (i.e., t-test).

As expected for steering time series, there are no level changes for pre-intervention and post-intervention segments: on a straight road, the mean value of

steering angle should be zero to keep vehicle in the lane. The slopes for steering angle do not differ as well. The slopes were always zero for all three driving conditions because left and right corrective movements (i.e., negative and positive values of steering angle) are equally distributed across the entire segment (Figure 15, left graph).

To reveal changes in steering movements, absolute values of the steering angle were fitted with the regression model. As a result, the trend difference for pre-intervention and post-intervention segments was significant for visual distraction ( $M=0.03$ ,  $SD=0.64$ ),  $t(11)=3.32$ ,  $p=0.007$  and for cognitive/visual distraction ( $M=0.001$ ,  $SD=0.001$ ),  $t(11)=2.56$ ,  $p=0.03$ . For cognitive distraction, there was no difference in trend values. This result confirms that steering angle amplitude increases with off-road glances causing standard deviation increase. This analysis shows that presence of off-road glances changes property of a steering signal from stationary to non-stationary. Thus, for the model identification, the segments of data that do not include off-road glances should be used.

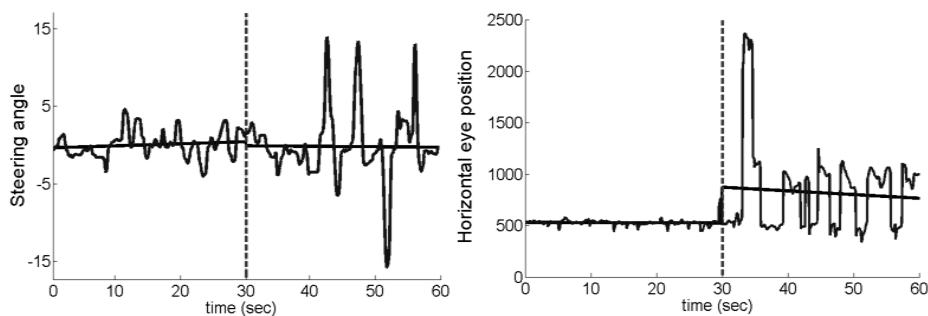

Figure 15. Interrupted time series analysis of steering angle (left) and horizontal eye position (right): the time series fitted with polynomial function

For horizontal eye position, changes in level happen with visual and cognitive/visual distractions when eye movement activity increases toward in-vehicle display area and back to the road area (Figure 15, b and Figure 16, a). The level (i.e., mean value of horizontal eye position) significantly increases for visual distraction when drivers equally likely divided glances between driving scene and in-vehicle display. For cognitive/visual condition, the glances are more likely concentrated on the road ahead than at the in-vehicle display area; and the changes in level are not significant. For these two conditions, variation in slope and level increases.

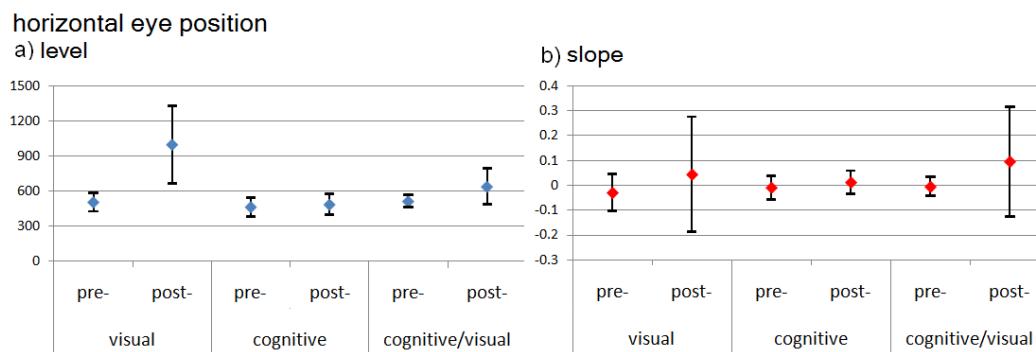

Figure 16. Calculated (a) level and (b) slope mean values (with standard deviation bar) for horizontal eye position time series

The slopes in pre-intervention and post-intervention segments do not significantly differ from zero for all the distracted conditions (Figure 16, b). This result does not confirm the hypothesis about the intervention effect of distraction on horizontal eye position time series. As it was for steering angle, this outcome can be accounted for the equally distributed on-road and off-road glances across the whole segment (Figure 15). The presence of trend in horizontal eye position time series will also be examined in the next chapter for each 30-second segment

used for system identification. All the statistical results for horizontal eye position are presented in Table 7.

Table 7. Summary of interrupted time series analysis for horizontal eye position

Condition	Parameters		M	SD	t	df	p
Visual task	slope	pre-	-0.03	0.07	-1.35	11	0.20
		post-	0.04	0.23	0.66	11	0.52
	level	diff*	493.14	349.40	4.89	11	0.0005
		pre-	507.93	80.02			
		post-	1001.07	333.99			
Cognitive task	slope	pre-	-0.01	0.05	-0.61	10	0.55
		post-	0.01	0.05	0.86	10	0.40
	level	diff*	20.77	49.46	1.39	10	0.19
		pre-	467.04	80.71			
		post-	487.81	89.29			
Cognitive/visual task	slope	pre-	0.00	0.04	-0.43	11	0.68
		post-	0.09	0.22	1.50	11	0.16
	level	diff*	125.42	134.84	3.22	11	0.01
		pre-	515.06	53.97			
		post-	640.48	154.36			

\* Test performed for the  $b_2$  coefficient from equation (5), i.e., differences between two values

### Correlation analysis of eye and steering movements

The correlation analysis was carried out to describe some statistical characteristics of eye position and steering angle time series and their relationship for different conditions (i.e., non-distracted and distracted). The auto-correlation analysis examines a relationship between two different points of time series to elicit properties of the signals, i.e., randomness or periodicity. The cross-correlation analysis examines the similarity between time series, i.e., if one signal causes changes in the other one. This analysis tests the hypothesis that both horizontal eye position and steering angle time series are close to random for baseline condition and change their properties with distraction, e.g., get periodic properties with visual distraction.

It was expected that the correlation between these two signals would vary with the presence of distraction. It will be low for baseline (non-distracted) driving because eye movement associated with road scanning at straight roads is less likely to direct steering. A qualitatively different relationship is expected between eye and steering movements with presence of off-road glances. While performing visual task, drivers share their attention between driving scene and task performance area, e.g., in-vehicle display. Glances away from the road are associated with loss of information that is necessary for vehicle control. Glances back to the road are coupled with steering movements to correct the state of the vehicle in the lane. This coupling is most likely to increase the correlation between these two signals. It is also expected that eye-steering correlation will change with cognitive distraction but not significantly.

To perform this analysis, the data from 12 drivers were divided into 30-second non-overlapping segments. The interrupted time series analysis showed that segments of horizontal eye position and steering angle from all the driving conditions had non-significant trends fluctuating around zero. However, to elicit the properties of the signals, all the segments were detrended to remove any slope and mean. Auto- and cross-correlation functions are calculated using Signal Processing Toolbox Software (Version 6.13 of Matlab R2010a). The 30-second segment at frequency of 60 Hz includes 1800 samples. The correlation functions are calculated for first 480 lags (8 seconds) (see *Signal length and sampling* section).

The visual inspection of calculated autocorrelation functions for baseline condition shows that these signals are close to random but not completely – the function decrease quickly from its peak value at zero lag but has values out of 95% confidence interval (CI) (Figure 17, a). The CI is computed as  $0 \pm 1.96/N$  following an assumption that the sample correlations are normally distributed with mean zero

and variance  $1/N$ , where  $N$  is a sample size. For the 0.05  $\alpha$ -level and two-tailed test, the value 1.96 is the 0.975 probability point of the cumulative distribution function (Gottman, 1981).

The short-term correlation – the large values of autocorrelation function that follow the peak value at zero lag and tend to get smaller – was expected and can be accounted for the dependency of the eye and steering wheel current positions on their preceding values. For some segments, the autocorrelation coefficient outside the 95% CI at larger lags can be associated with different types of eye movements, i.e., glance shifts between driving scene and out of driving scene at instrument panel and at unexpected locations (unusual glances) (Figure 14 and Table 5). In general, the correlation between these two signals is low. This implies that visual “input” on the straight road is not strong enough to generate steering movements as an output as it was on curvy roads (Land, 2006).

The auto-correlation functions for both signals are changed with visual distraction. The signs of periodicity appear in this condition and are designated by the peaks out of 95% CI at non-zero lags (Figure 17, b). This is more apparent for horizontal eye position compared with steering angle – the peaks are higher for eye signal than for steering signal. This periodicity in eye movements indicates iterative glance switches between on-road and off-road areas. The relatively lower correlation in steering movement implies that drivers do not lose their lane keeping control with every off-road glance and hence, they do not steer with the same periodicity and amplitude to correct their position in the lane. This could be a reason of low correlation between eye and steering movements.

The autocorrelation functions calculated for cognitively and cognitively/visually distracted conditions differ from the ones for baseline and visual conditions (Figure 17, c and d). The correlation is stronger for some non-zero lags than that was for baseline condition but the functions are not periodic.

This indicates that correlation characteristics (e.g., strength of observations dependence) of the time series are changed with these two types of distraction.

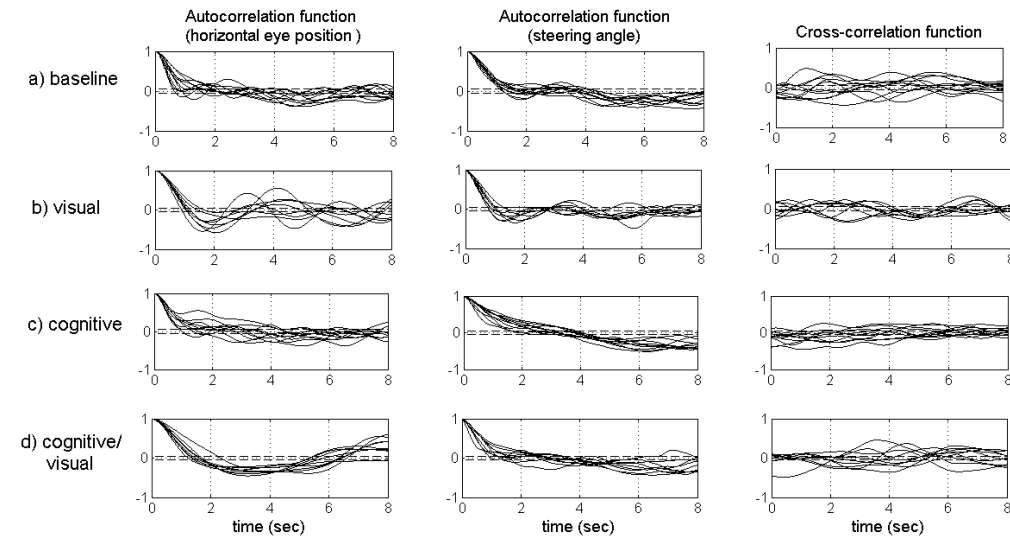

Figure 17. An example of autocorrelation and cross-correlation functions for detrended steering angle and horizontal eye position for no-distraction and distracted conditions. The functions were calculated for all the 30-second segments from Subject 4 driving session. The dashed lines are 95% confidence intervals.

To examine the autocorrelation function changes associated with distraction, the magnitudes of the first peaks that exceed confidence interval (autocorrelation coefficient) and their x-values (lag time) were compared. The analysis was performed through a within-subject ANOVA with repeated measures by using SAS 9.2 PROC MIXED procedure. The analysis show that, for horizontal eye position, both measures are changed significantly (autocorrelation coefficient:  $F(3,31)=18.05, p<.0001$ ; time lag:  $F(3,31)=35.34, p<.0001$ ). For steering angle, time lag changes significantly ( $F(3,28)=5.40, p=0.005$ ) but the autocorrelation coefficient does not:  $F(3,28)=1.86, p=0.16$  (Figure 18).



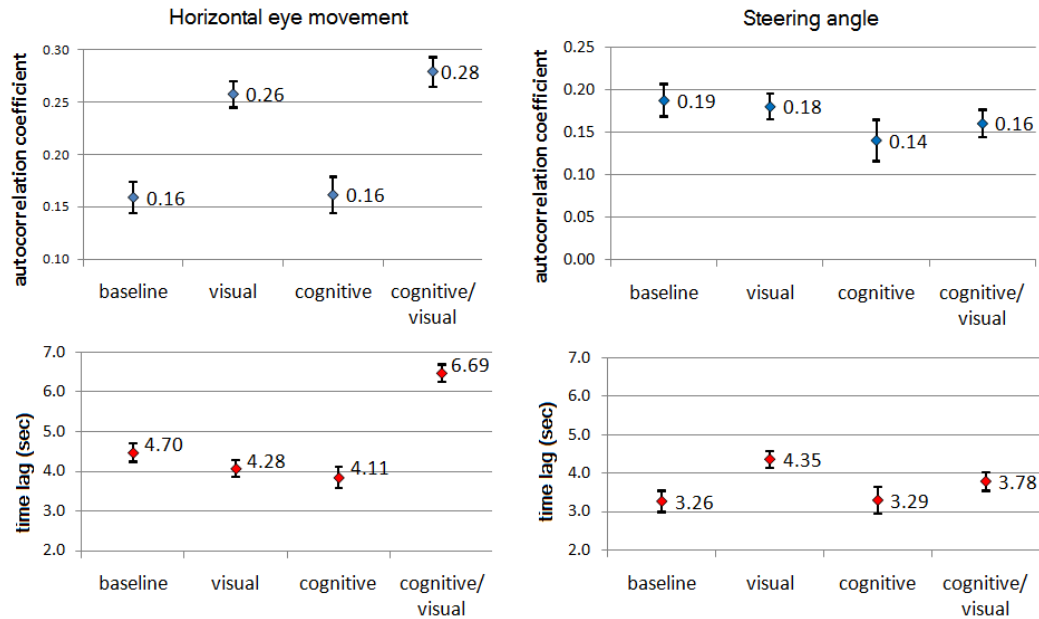

Figure 18. Autocorrelation coefficient and time lag changes with distracted condition

The results of pair-wise comparison (Tukey's test) between distracted conditions indicate that the autocorrelation coefficient of horizontal eye position time series is sensitive to distraction associated with off-road glances: the autocorrelation coefficients for visual and cognitive/visual conditions are significantly different from the ones for baseline and cognitive conditions (Table 8). Off-road glances affect time lag of both horizontal eye position and steering angle time series. However, these changes are not consistent. For horizontal eye position, cognitive/visual distraction leads to the largest time lag compared to the rest of conditions, but visual distraction does not affect the time lag significantly. On the contrary, for steering angle, visual distraction causes increases the time lag but cognitive/visual distraction does not.

To examine the correlation between signals for all four driving conditions, the magnitudes of cross-correlation function's first peaks (cross-correlation

coefficient) and their time delay were extracted. The values of the cross-correlation coefficient are negative and positive indicating both types of correlation. On straight roads, the departures from the centerline could happen in both directions regardless from the glance direction. These deviations cause equally possible negative and positive changes in steering angle (i.e., steering to the left and to the right) and, consequently, negative and positive eye-steering correlation coefficient. Therefore, the absolute values of cross-correlation coefficient are examined to evaluate the strength of correlation.

Table 8. Statistical results of the autocorrelation coefficient and time delay (in seconds) pair-wise comparison

Correlation characteristics	B vs. V	B vs. C	B vs. C/V	V vs. C	V vs. C/V	C vs. C/V
<b>Horizontal eye position</b>	$t(31)$	$t(31)$	$t(31)$	$t(31)$	$t(31)$	$t(31)$
Autocorrelation coefficient	<b>-5.03</b>	-0.11	<b>-5.84</b>	<b>4.47</b>	-1.13	<b>-5.26</b>
Time delay	1.47	1.96	<b>-6.99</b>	0.75	<b>-9.04</b>	<b>-8.38</b>
<b>Steering angle</b>	$t(28)$	$t(28)$	$t(28)$	$t(28)$	$t(28)$	$t(28)$
Autocorrelation coefficient	Not significant					
Time delay	<b>-3.54</b>	-0.07	-1.62	<b>2.84</b>	<b>2.08</b>	-1.28

For bolded values test obtained significant difference at  $\alpha=0.05$ ; B, V, C, and C/V indicate the estimated value of the measures under baseline, visual distraction, cognitive distraction, and cognitive/visual distraction conditions

The correlation parameters (cross-correlation coefficient and time delay) are examined for all the driving conditions. The results show that driving condition has a statistically significant effect on both parameters – cross-correlation coefficient ( $F(3,32)=8.69$ ,  $p=0.0002$ ) and time delay (Welch's test:  $F(3)=9.16$ ,  $p<.0001$ ). Because the correlation analysis was performed for consecutive segments of data, the effect of sequence of segments was examined for each

distracted condition. It has no effect on correlation parameters: for correlation coefficient,  $F(10, 107)=0.60, p= 0.81$ ; and for time delay,  $F(10, 107)=0.43, p= 0.93$ .

Post-hoc comparison between driving conditions shows that the correlation coefficient is significantly higher for baseline and cognitive driving conditions than for visual and cognitive/visual ones (Figure 19, Table 9). This result supports the hypothesis that the correlation coefficient changes with off-road glances. It was expected that the correlation would increase with visual distraction because of the coupling of steering movements and eye movements. This analysis shows the opposite: the correlation coefficient decreases with visual distraction compared with baseline and cognitively distracted conditions. The obtained result is in agreement with studies of eye-steering correlation on curvy roads when driver impaired condition caused diminished coordination (Marple-Horvat, Cooper et al., 2008; Wilson, Chattington et al., 2008). The lowest value of the correlation coefficient was for cognitive/visual distraction indicating that this is a different type of distraction: it has a different effect on correlation coefficient.

The time delay changes across all the conditions: it significantly decreases with visual and cognitive distraction and increases with cognitive/visual. The post-hoc pair-wise comparison indicates that the time delays for all the conditions are significantly different but not between visual and cognitive conditions (Table 9). The time delay, which corresponds to the degree that eye movements lead steering wheel movements, decrease in a way that matches the results of eye-steering coordination study for alcohol impaired driving on a curvy road (Marple-Horvat, Cooper et al., 2008). This reduction is accounted for diminished function of the oculomotor controller: the late signal to the neural controllers for eye movement caused delayed response from oculomotor controller.

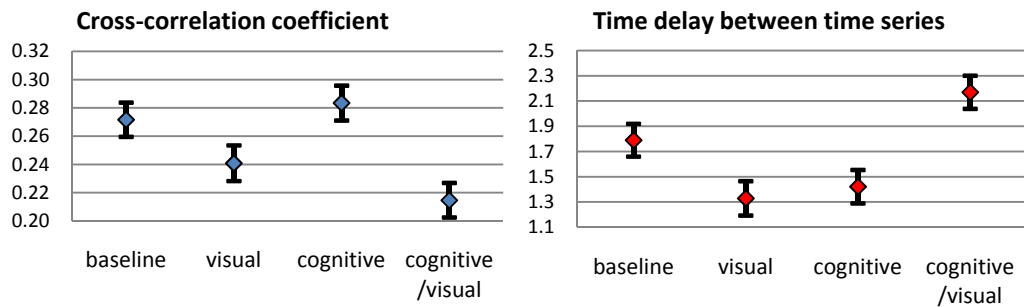

M	0.27	0.24	0.29	0.21		1.79	1.34	1.44	1.18
SD	0.13	0.10	0.13	0.10		1.54	0.95	1.14	1.60

Figure 19. Cross-correlation analysis statistics: mean values with standard error bar for correlation coefficient and time delay (in seconds)

Table 9. Statistical results of the pair-wise comparisons

Correlation characteristics	B vs. V	B vs. C	B vs. C/V	V vs. C	V vs. C/V	C vs. C/V
	<i>t</i> (32)	<i>t</i> (32)	<i>t</i> (32)	<i>t</i> (32)	<i>t</i> (32)	<i>t</i> (32)
Correlation coefficient	<b>2.01</b>	-0.88	<b>3.83</b>	<b>-2.83</b>	1.72*	<b>4.64</b>
Time delay	<b>2.56</b>	<b>2.05</b>	<b>-2.21</b>	-0.52	<b>-4.71</b>	<b>-4.22</b>

For bolded values test obtained significant difference at  $\alpha=0.05$ ; \* the difference is marginally significant; B, V, C, and C/V indicate the estimated value of the measures under baseline condition, visual distraction, cognitive distraction, and cognitive/visual distraction

The observed time delays associated with oculomotor controller are in the range of 200–300 ms for visually guided tracking and about 700 ms for normal driving on curvy roads (Miall and Reckess, 2002). This difference in time delays is most likely affected by the nature of the tasks (Land, Mennie et al., 1999). In this study, the time delay mean value is 1.8 seconds. Distraction decreases timing between these two movements, and it is most likely due to changes of oculomotor controller function. However, this issue requires more investigation, especially, the

fact that visual and cognitive distractions cause decrease of time delay but visual/cognitive distraction causes increase.

Overall, these results indicate that the time delay and correlation coefficient can be used as diagnostic measures of distraction. The changes in time delay and correlation coefficient suggest that they can reflect differences between not only distracted and non-distracted driving, but also can differentiate between the types of distraction, i.e., visual, cognitive, and cognitive/visual. Due to this, the eye-steering model could reveal sensitivity to the type of distraction as well. This hypothesis will be tested in the next chapter.

### Conclusion

Two analyses were carried out to examine the properties of horizontal eye position and steering angle time series and their changes with distraction: visual, cognitive, and cognitive/visual. The first analysis – interrupted time series analysis – examines the intervention effect of distraction, i.e., the changes in time series in term of slope and level for distracted condition compared to baseline (non-distracted) condition. The second analysis – correlation analysis – examines the relationship between two different points of time series to elicit correlation properties within and between the signals through autocorrelation and cross-correlation functions respectively. This analysis tested the hypothesis that the correlation characteristics of the signals – correlation coefficient and time delay – change with presence of distraction.

The results of these analyses are important for eye-steering system modeling. They show (1) that the trend should not be modeled before eye-steering system identification, and (2) the expected eye-steering model performance

changes associated with distraction would be caused not by variations of a trend but by correlation statistics changes.

As expected, the level of steering angle time series did not change with distraction. The slope did not change as well. This result can be accounted for the presence of left and right corrective steering movements equally distributed across the whole segment (Figure 15). However, the off-road glances cause steering angle standard deviation increase indicating that the presence of off-road glances makes a signal non-stationary relative to non-distracted driving.

For horizontal eye position, the mean values of slopes increased for visual and cognitive/visual distraction conditions compared with baseline condition, but not significantly. As expected, significant change in level occurs with off-road glances (for visual and cognitive/visual conditions) because of the shifted mean position of glances toward the in-vehicle display area where the visual task was performed.

Generally, the interrupted time series analysis revealed that both horizontal eye position and steering angle time series do not have significant trends associated with distraction. This means that trends should not be modeled before system identification. Furthermore, assuming that the eye-steering model developed for baseline driving will change its performance when signal from distracted driving will be used as an input, these changes will not be caused by variations in trend.

The correlation analysis of the time series for baseline condition shows that there is a short-term correlation between points implying a dependency between current point and its preceding values. This relationship can support building a model to predict the current position through its previous values. Presence of off-road glances changes properties of both eye and steering time series. For visually distracted condition, the autocorrelation functions reflect some periodicity

associated with glance shifts between on-road and off-road areas and consecutive intensive steering movements. These changes identify driver state changes. The shape of autocorrelation functions for cognitive and cognitive/visual task condition also has been changed: there are more peaks at non-zero lags than for the baseline condition indicating changes in the strength of association between observations.

These changes in association were assessed through the autocorrelation coefficient and time lag. This assessment showed that these measures change with off-road glances in a different way. The autocorrelation coefficient changes with off-road glances for horizontal eye position but does not change for steering angle. Time lag increases significantly with cognitive/visual distraction for horizontal eye position and with visual distraction for steering angle.

These changes in autocorrelation functions cause changes in the cross-correlation function. According to Land's theory, the eye and steering movements are highly coordinated on winding open roads because visual information about the road curvature is a strong input to the steering controller (Land and Horwood, 1995). Driver impairment associated with alcohol and fatigue has been shown to diminish this coordination. On a straight open road, this eye-steering relationship is different: eyes do not move to guide steering; eyes scan driving environment to maintain situation awareness not to solely guide steering movements. This implies that, in general, the eye-steering correlation should be lower on a straight road compared with curvy road. The eye-steering correlation could increase slightly for visual and cognitive/visual conditions compared with baseline and cognitive conditions. This increase would be associated with coupling eye and steering movements: glance shifts between on-road and off-road areas cause corrective steering movements to keep vehicle in a lane.

The eye-steering relationship is evaluated through the correlation coefficient, the absolute magnitude of a cross correlation function first peak and

time delay, the position of a first peak. Both these characteristics are found sensitive to distraction. The correlation coefficient is sensitive to distraction associated with off-road glances, i.e., visual and cognitive/visual distraction. It does not change significantly with cognitive task. The time delay is sensitive to all three types of distraction. The same result of correlation coefficient and time delay decrease was observed with driver impaired condition on curvy roads (Marple-Horvat, Cooper et al., 2008; Wilson, Chattington et al., 2008). An interesting result was for cognitive/visual distraction: it was the only type of distraction where both time delay and correlation coefficient changed significantly. Moreover, the amplitude of these changes was the largest, indicating that cognitive/visual distraction affects eye and steering movements in a different way compared to visual and cognitive distraction.

These changes in eye-steering relationship measured through correlation coefficient (CC) and time delay (TD) can be used for distraction differentiation: (1) for visual distraction, both CC and TD decrease; (2) for cognitive distraction, TD decreases and CC does not change; and (3) for cognitive/visual distraction, CC decreases and TD increases (Figure 19). All the comparisons are done relative to the baseline condition. This differentiation can help in driver state identification. The model defined for baseline condition based on eye and steering movements can differentiate driver state when data from distracted driving are used as an input into the model. Based on CC and TD changes, the defined model can not only differentiate distracted from non-distracted driving but also differentiate types of distraction: visual, cognitive, and cognitive/visual.

In overall, these two analyses show that for eye-steering system definition, the trend of a steering angle time series does not have to be modeled separately: it does not differ from zero for the baseline condition. It is most likely, that the performance of the model defined for baseline condition will be changed



significantly with distraction. These changes will be caused by the changes in correlation statistics, time delay and correlation coefficient, and not by the changes in trend. The variation in time delay and correlation coefficient revealed by the analysis in this chapter suggests properties in drivers' looking and steering behavior can support a model that will reflect differences between not only distracted and non-distracted driving, but also between the types of distraction, i.e., visual, cognitive, and cognitive/visual. This hypothesis will be tested in the next chapter.

## CHAPTER 4. DRIVER STATE ASSESSMENT THROUGH THE SYSTEM IDENTIFICATION APPROACH

A system identification approach is used to construct mathematical models of eye-steering system from input-output data. This black-box modeling approach fits linear and nonlinear models to data. The fit of the models to the data and the values of model parameters might be useful indicators of distraction and might also differentiate types of distraction.

### Analysis method

Parametric models are used to predict steering wheel angle through its previous values and eye movement location. This approach identifies a model that takes horizontal eye position as an input and generates steering angle as an output.

It is hypothesized that the model defined for the stationary data from non-distracted driving will result in different model fit values when data from distracted driving are used as an input into this model. If this hypothesis is confirmed, then model performance (measured through the *Best Fit* value) as a driver state classifier can identify distracted driving. Model performance will be evaluated using a confusion matrix as well.

The results of the correlation analysis can be used to identify the model structure: the correlation within steering time series and between eye and steering time series allows prediction of a current value of steering signal through its previous values and eye position. The time delay defined through the cross-correlation analysis in the previous chapter will be examined as relative timing between input and output.

### System identification

The candidate models that can predict steering wheel position using only previous states of the steering output are ARIMA, ARMA, and AR time series modeling structures. Models that predict steering wheel position using previous states of the steering output and current and previous states of the horizontal eye position input are ARX and ARMAX models (Table 4). An advantage of the models with moving average (MA) term is more flexibility in modeling disturbances than models without MA. The models with MA terms predict the current value of the series against previous white noise error terms or random shocks that propagate to future values of the time series. On the other hand, AR and ARX structures are simpler if the disturbances are a part of the system and could be represented as white noise. For the purpose of this study, the consideration of the ARX structure is more appropriate because (1) it combines two variables that represent driving and visual behavior; (2) it considers time delay between input and output that is indicative of distraction.

It was shown previously that vertical eye movement has not been changed significantly for different driver states (Wilson, Chattington et al., 2008); and it was not correlated with steering movements (Wilson, Stephenson et al., 2007). Thus, horizontal eye position will be considered as the input to the steering controller.

Modeling should be done under the assumption that the signal is stationary (Ljung, 1987). The signal stationarity assumes that a mathematical model should be based on the process that is unchanged and stable during the time of prediction. This assumption implies that the mean, variance, and autocorrelation do not change over the time of prediction (Gottman, 1981). Thus, non-stationary data cannot be modeled or forecasted, it needs to be transformed into trend stationary data. However, eye movement non-stationarity could indicate changes in glance

type and, consequently distracted driving. Therefore, all the segments of data should be tested for presence of trend. Before removing trend from the time series, i.e., subtracting the best-fit line from the data, it should be modeled. Removing a trend from the data focuses the analysis on the fluctuations in the data about the trend.

### Model estimation

The ARX model structure is defined by the three parameters  $n_a$ ,  $n_b$ , and  $n_k$  from equation (3). Guided by the correlation analysis, time delay that corresponds to the x-value of a cross-correlation function maximum peak can be used for  $n_k$  selection. Nevertheless, the time delay and the optimal number of previous inputs  $n_b$  and previous outputs  $n_a$  terms will be defined by examining models with different sets of values and will be based on the model fit parameters.

The prediction error method (PEM) is applied to model parameter identification (Ljung, 1987), where a prediction error is defined as a sum of squares of differences between validation data output and one-step-ahead predicted output. The parameters of the model will be estimated and tested for statistical significance using the least squares method (as a special case of PEM) that minimizes the error term through determining  $G(q) = B(q)/A(q)$  and  $H(q) = 1/A(q)$  parameters (see ARX structure in Table 4):

$$[G_n H_n] = \arg \min \sum_{t=1}^n e(t)^2$$

$$\text{where } e(t) = H^{-1}(q)[y(t) - G(q)u(t)]$$

The candidate models will be examined on the prediction error using the Akaike Information Criterion (AIC) or Akaike Final Prediction Error (FPE) as measures of model quality. AIC and FPE are defined by the equations

$$FPE = V\left(\frac{1 + d/N}{1 - d/N}\right) \quad (8)$$

and

$$AIC = \log V + \frac{2d}{N} = \log \left( V \left( 1 + \frac{2d}{N} \right) \right) \approx \log FPE \text{ for } d \ll N$$

$$\text{where } V = \frac{1}{N} \sum_{t=1}^N e^2(t)$$

is the loss function,  $d$  is the number of estimated parameters, and  $N$  is the number of values in the estimation dataset.

The lower the prediction error value the better the model. The choice of AIC or FPE rather than  $R^2$  is that even the adjusted  $R^2$  value might lead to inclusion of additional model parameters and result in overfitting. Therefore, based on a high  $R^2$  value, the best model will be the most complex one. Since the model simplicity is a critical aspect in model definition, the models will be compared with the information lost criteria, i.e., AIC or FPE, as a measure of both accuracy and complexity.

#### Model validation

The selected models (with the lowest order and prediction error) will be evaluated by (1) *Best Fit* value that compares simulated or predicted output with measured output; and (2) residuals' analyses.

The *Best Fit* shows the percentage of the output that the model reproduces and computes as

$$Best\ Fit = \left[ 1 - \frac{|y - \hat{y}|}{|y - \mu|} \right] \times 100 \quad (9)$$

where  $y$  is the measured output,  $\hat{y}$  is the simulated or predicted model output, and  $\mu$  is the mean of  $y$ . The closer the value is to 100% the better the fit. When the value is 0%, the fit is no better than guessing the output to be a constant ( $\hat{y} = \mu$ ). The *Best Fit* is a model performance function that is essentially the  $R^2$  value. *Best Fit* could be negative indicating that the estimation algorithm failed to converge.

The model validation process includes an analysis of residuals: the examination of the residuals' auto-correlation and cross-correlation with the input (Ljung, 1987). The residual function of a good model should be white noise. This assumes that the noise signal should be a random function that is not correlated with itself. Based on equation (6), the auto-correlation function of the residuals defined as

$$R_{ee}(k) = \frac{1}{n} \sum_{t=1}^n e(t-k)e(t)$$

should tend to 0 for any non-zero  $k$  and do not leave the confidence interval. The exceedence of the confidence interval could indicate that the model structure does not fully account for the data. Examination of system linearity could also be based on the tendency of normalized cross correlation function toward one. In the frequency domain, the coherence test is used to determine the presence of a linear relationship between input and output. The tendency of the coherence function to zero could be a result of one of the following conditions: (1) noise contaminates the measurements, (2) another input affects the output, and (3) the relationship between input and output is nonlinear.

The analysis of the cross-correlation function defined by equation (7) between the residuals and the inputs evaluates if the model properly represents the relationship between signals:

$$R_{ue}(k) = \frac{1}{n} \sum_{t=1}^n u(t-k)e(t)$$

A cross-correlation function that exceeds the confidence interval suggests that the output is not properly described. The correlation between  $u(t-k)$  and  $e(t)$  for negative  $k$ , is an indicator of feedback in the model. A slowly varying cross correlation function outside the confidence region indicate an insufficient number of sampling intervals between the most and least delayed output. The

presence of peaks is an indicator of a small number of sampling intervals between the most and least delayed input or wrong number of delayed samples between input and output (Ljung, 1995).

Thus, it is assumed that a good model should have (1) the residual autocorrelation function inside the confidence interval, indicating that the residuals are uncorrelated, i.e., normally distributed white noise (whiteness test); and (2) a cross-correlation function that lies inside the confidence interval, indicating that the residuals are uncorrelated with past inputs (independency test).

#### Driver state differentiation through eye-steering system modeling

As a preliminary study, two different models were developed for non-distracted and distracted driving to examine the changes in transfer functions caused by driver state. The black-box modeling approach was used to define the relationship between eye signal as an input and steering signal as an output. The parametric models with ARX structure were considered to describe the system dynamics using transfer functions. It was hypothesized that the difference in models structure, orders, parameters, and fit can indicate different states of a driver.

Steering and visual behavior was compared for non-distracted and visually distracted conditions for 12 subjects through histogram plots (Figure 20). The comparison indicated that, in general, distribution shapes for steering angle have normal tendencies with zero mean for both conditions. In general, the drivers performed differently under these two conditions: while driving without distraction, the driver made some adjustments with small steering angles, and the range of the angles increased with distracting driving.

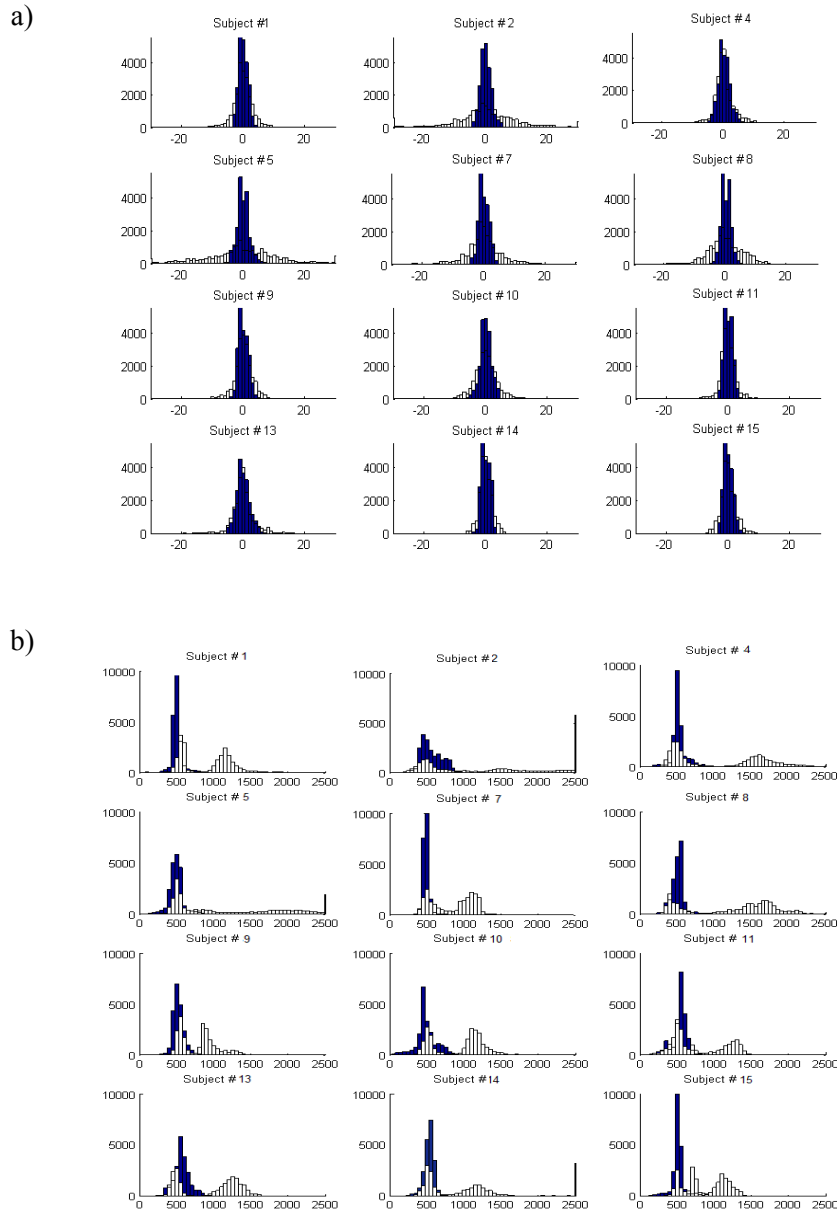

Figure 20. Distribution of (a) steering angle and (b) horizontal eye position for non-distracted (dark bars) and visually distracted (white bars) conditions

The horizontal eye position for non-distracted driving has distribution close to normal in most cases and it becomes bimodal designating that glances



distributed between on-road area and off-road area, i.e., in-vehicle display. This examination shows that driving behavior, i.e., eye and steering movements, is different across the drivers. The presence of unusual glances that could be considered as outliers (subjects 2, 5, and 14) are revealed through the visual inspection of the histograms.

The difference in driving behavior for non-distracted and visually distracted conditions is revealed through the spectrum analysis (Figure 21): there is a shift from lower frequencies for non-distracted driving toward higher values for visually distracted driving. The average fundamental frequency in horizontal eye position signal is 0.026 Hz (cycle time of 38 seconds) and in steering angle signal is 0.069 Hz (cycle time of 14 seconds) (see also Table 6). Such a relatively low fundamental frequency (long cycle) in signals for non-distracted driving can imply that the periodic component in these signals is absent and they can be considered random. The signs of periodicity appear with visual distraction, when cycle lengths decrease and become 4 seconds and 6 seconds for eye and steering movements respectively.

For eye-steering system identification, simulator driving data from Subject 2 was chosen. Here, the difference in steering performance for distracted and non-distracted driving was explicit: the distribution for distracted driving is more scattered than that for non-distracted driving (Figure 20, a). The signals were broken down into ten-second non-overlapping rectangular windows (600 samples at 60 Hz). The choice of the window size was based on the intention of determining stationary segments of data that include at least three glances and could be used without any reduction. Thus, for the model identification and validation, the segments of data that do not contain non-task relevant glances were used.

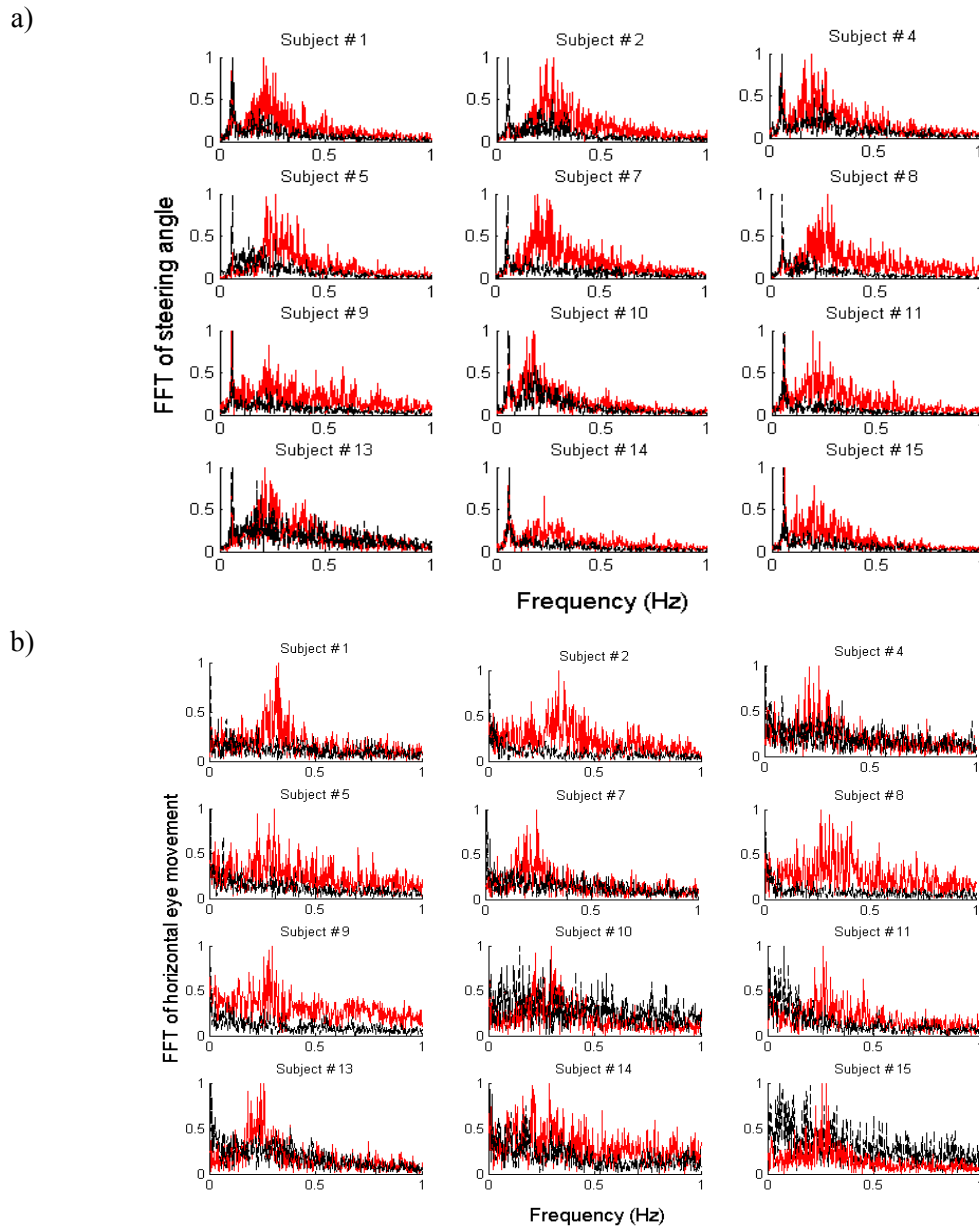

Figure 21. Detrended (a) steering angle and (b) horizontal eye position spectra for non-distracted (black line) and distracted (red line) conditions

The signals were detrended to remove means and any linear trend and filtered to remove high frequency components. The auto- and cross- correlation functions were calculated for both conditions: non-distracted and visually distracted. The auto-correlation functions for non-distracted condition showed that

the horizontal eye and the steering movements could be considered as random signals: the functions decrease faster than linear function (Gottman, 1981) (Figure 22).

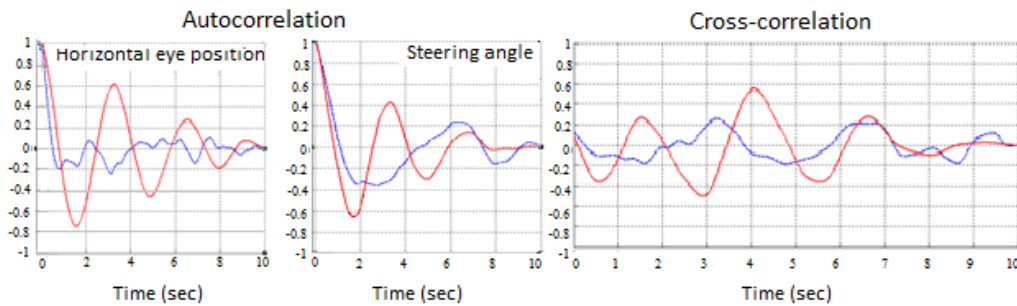

Figure 22. Auto- and cross- correlation functions calculated for eye and steering signals for 10-second segments of non-distracted (blue line) and distracted (red line) conditions

The correlation between signals was low. The auto-correlation functions suggest periodicity and strong coupling in the distracted condition. This periodicity might indicate glance switches between on-road and off-road areas and subsequent corrective steering movements. The cross-correlation coefficient between these signals also increased with distraction.

#### Eye-steering model estimation

To describe the dynamics of the system by means of a transfer function and simplify the calculations, a parametric modeling approach is considered. This approach estimates the parameters or transfer functions of a specified model structure using input and output data. The advantage of parametric modeling is that the output can be easier to interpret as compared to non-parametric approach.

Model accuracy and simplicity are two issues that should be combined in the model design: the large number of parameters can increase the precision of the

model but, at the same time, can result in modeling of nonexistent dynamics and noise characteristics. The strategy for modeling was to start with the simplest design and to increase the complexity to improve the model performance by considering noise structure, non-linearity, and an additional input (i.e., external disturbance). The non-linear structure was considered because the coherence spectrum showed that the relationship between input and output, i.e. coherence function, did not tend to one. An additional input was considered because plotting eye and steering signals with external disturbance showed that although the steering movements for some degree are coordinated with eye glance movements, there is a probability that the external disturbance simulates some steering movements as well (Figure 23, points 3 and 4 on the graph).

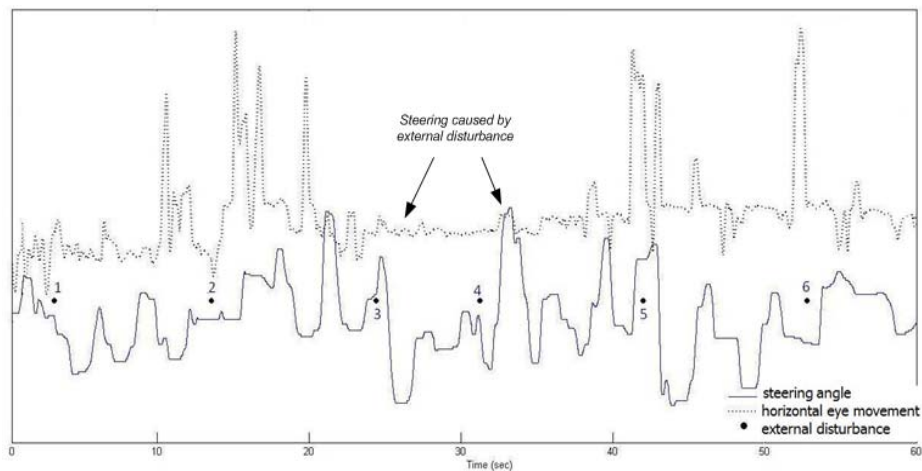

Figure 23. Steering angle and horizontal eye position (60-second sample of non-distracted driving)

Among parametric models, the ARX model has the simplest structure defined by equation (3). The proposed model has horizontal eye position as a single input and a single output that is a steering angle. Two different 10-second

samples of simulated driving for each condition were used for model estimation and validation purposes. These two segments had similar autocorrelation functions shapes. They passed the stationarity reverse arrangement test – the evaluation of statistical independence of data and underlying trends – with  $\alpha = 0.05$  for steering signal and with  $\alpha = 0.01$  for eye movement signal. The means were removed before starting the process of model identification.

#### Eye-steering model validation

Different sets of model order ( $n_a$  and  $n_b$ , ) and delay  $n_k$  were examined. The candidate models were selected based on a model accuracy measure, i.e., FPE defined by equation (8). The best model choice was based on how well the simulated output matches the measured output (*Best Fit* value defined by equation (9) and through the analysis of residuals. Thus, to validate the model, the models with different orders and delays that had the smallest values of FPE (similar to AIC based on equation 8) were evaluated through the *Best Fit*. The residuals were tested on whiteness and the independence.

Different combinations of order and delay were examined to find a structure with the lowest prediction error and order. Based on this selection, three candidate models were compared for the *Best Fit* and output residuals (Figure 24). This comparison showed that the ARX model (arx131226) could be considered as the best one. In this model, the number of previous outputs on which the current output depends ( $n_a$ ) is 13, and the input is delayed by 3.77 sec ( $n_k = 226$ ). This model has the highest *Best Fit* value of 43.42 %; and residuals passed the whiteness and independence tests with the 99% confidence interval (Figure 24, b).

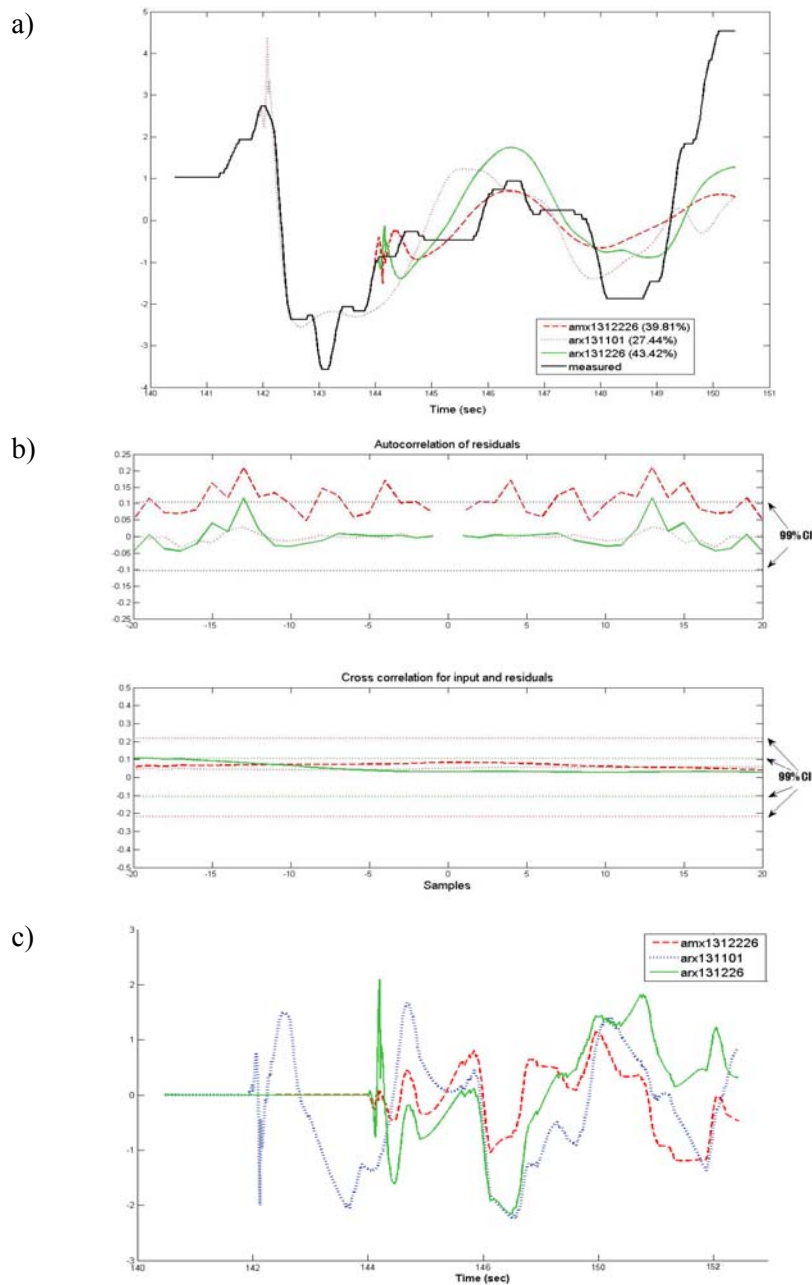

Figure 24. Comparison of candidate models for baseline driving: a) simulated and measured output comparison with Best Fit values; b) auto- and cross-correlation for residuals (the horizontal scale is the number of lags (samples) between the signals at which the correlation is estimated); and c) measured minus simulated output (error)

The consideration of the noise in the model as a separate term through the ARMAX structure (amx1312226) did not improve model performance (*Best Fit* decreased to 39.81%) (Figure 24, c). Non-linear modeling with the same structure did not improve model performance as well. Moreover, the estimation algorithm failed to converge.

Both horizontal eye position and external disturbance were used as inputs – MISO model – to define if consideration of an additional input would improve the model. The comparison of SISO and MISO models showed that the outputs for both types of models were almost the same (Figure 25).

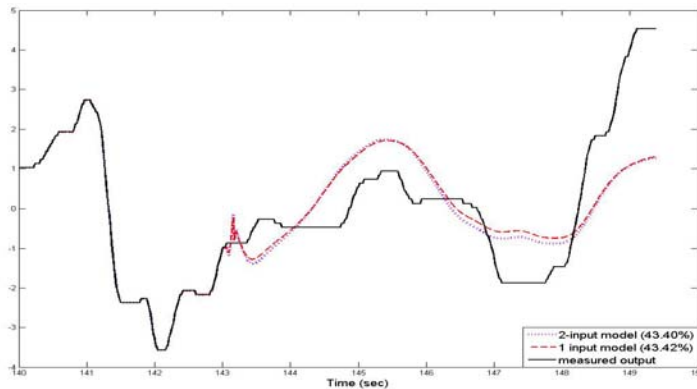

Figure 25. Comparison of SISO (one-input) and MISO (two-input) models

For the visual task, the model selection based on FPE value showed that the influence of the input upon the output was delayed by 4.77 sec (288 samples) (Table 10). The highest *Best Fit* value had the model with the lowest order: the number of previous outputs on which the current output depends ( $n_a$ ) was 3 (arx31288) (Figure 26, a). Analysis of the autocorrelation function for the residuals (whiteness test) showed that it exceeded the confidence interval of 99% indicating that the noise is not white (Figure 26, b). The large number of a sample size allows

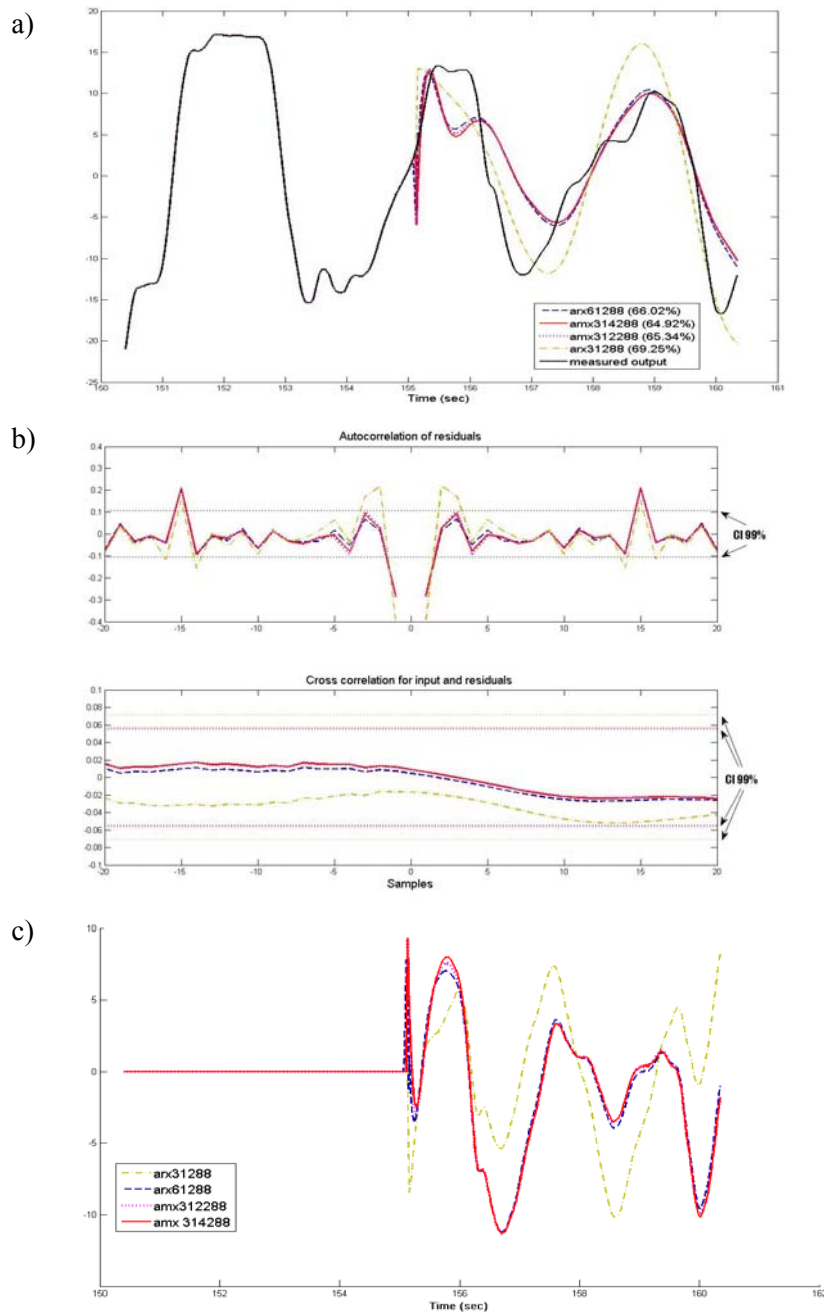

Figure 26. Comparison of candidate models for distracted driving (with visual task): a) simulated and measured output comparison with *Best Fit* values; b) auto- and cross- correlation for residuals (the horizontal scale is the number of lags (samples) between the signals at which the correlation is estimated); and c) measured minus simulated output (error)



choosing a liberal criterion of 99% for the confidence interval. The ARMAX model with the same structure (amx312288) improved the results of the autocorrelation function but caused *Best Fit* value decrease. The ARX model with  $n_a$  of 6 (arx61288) had similar residuals and *Best Fit* value. The error term for each structure is presented in Figure 26 (c). The interesting result is that the *Best Fit* (which is similar to  $R^2$ ) increases even though prediction error (FPE) increases. This result is consistent with the greater variability in steering during distraction.

Table 10. Summary of the models' estimation and validation characteristics

Models	Model order			Input delay	<i>Best Fit</i>	Prediction error
	number of previous outputs $n_a$	number of previous inputs $n_b$	number of error terms $n_c$	$n_k$ (delay in seconds)	Simulated output (%)	FPE
No task						
amx1312226	13	1	2	226 (3.75)	39.81	0.002
arx131101	13	1		101 (1.68)	27.44	0.001
arx131226	13	1		226 (3.75)	43.42	0.001
arx131122677 (2 inputs)	13	1		226 (3.75)	43.20	0.001
		1		77 (1.28)		
Visual task						
arx61288	6	1		288 (4.78)	66.02	0.004
amx314288	3	1	4	288 (4.78)	64.92	0.008
amx312288	3	1	2	288 (4.78)	65.34	0.008
arx31288	3	1		288 (4.78)	69.25	0.005
nlarx31288	3	1		288 (4.78)	-10.82*	0.010

\* Negative value of Best Fit indicates that estimation algorithm failed to converge

Two models with the best performance were selected to compare the transfer functions – arx131226 for non-distracted driving and amx312288 for

distracted driving (Table 11). The comparison of these two models has shown that they differ by structure, parameters, time delay, and the number of the previous outputs that affected the current output. The number of the previous outputs is 13 for the non-distracted condition and 3 for the distracted one. This difference indicates that the current position of steering angle for baseline driving depends on the previous positions up to 0.22 sec ( $n_a=13$ ), while this time interval for the distracted driving was very short – 0.005 sec ( $n_a= 3$ ) (Table 10).

Table 11. Eye-steering system models for distracted and non-distracted driving

Condition	Model structure	Coefficients for input, output and noise terms
Non-distracted	ARX structure: $A(q)y(t) = B(q)u(t) + e(t)$	$A(q) = 1 - 1.105 q^{-1} - 0.2679 q^{-2} + 0.03677 q^{-3} + 0.1086 q^{-4} + 0.1949 q^{-5} + 0.1821 q^{-6} - 0.08175 q^{-7} - 0.05496 q^{-8} + 0.02884 q^{-9} - 0.02148 q^{-10} - 0.06231 q^{-11} + 0.05494 q^{-12} - 0.01198 q^{-13}$ $B(q) = -0.0001277 q^{-226}$
Distracted (Visual task)	ARMAX structure: $A(q)y(t) = B(q)u(t) + C(q)e(t)$	$A(q) = 1 - 2.834 q^{-1} + 2.683 q^{-2} - 0.8485 q^{-3}$ $B(q) = -2.878e-006 q^{-288}$ $C(q) = 1 - 0.9361 q^{-1} + 0.3388 q^{-2}$

Low correlation between input and output (Figure 22) indicates that driver steering movements do not reflect how people look at the road to guide their steering while driving on a straight road with light traffic. Non-distracted drivers mostly scan a driving environment. Driver awareness about the situation on the road led to smooth steering corrections to keep the vehicle in the lane and this could explain the greater number of the previous steering positions that influence current position. The correlation coefficient increased with distracted driving: drivers looked away from the road, then back to the road, and then made corrective steering movements. The time delay between eye and steering movements

increased by 1 sec (from 3.75 for baseline driving to 4.78 for distracted driving) (Table 10). The same difference of 1 sec in time delays was observed between the peaks of the cross-correlation functions for distracted and non-distracted driving in (Figure 22). This difference indicated that the visual task performance delayed the steering movement by 1 sec compared with normal driving.

However, these models defined for a single driver 10-second driving might not generalize to other drivers. Time delay as well as parameters might differ significantly for the rest of the segments of the same driver or for other drivers.

Overall, the difference in transfer functions, time delays, and model structures for different distracted conditions showed that it is possible to differentiate distracted condition based on a system identification approach. The definition of a control eye–steering model could help identify impaired driving when changes in parameters or model performance are observed.

### Results and discussion

A black box modeling approach is used to construct a mathematical model of eye-steering system for all the drivers. This approach assumes that input-output data should define the parameters of the system. As it was shown in the previous section, changes in model parameters and structure might indicate changes in condition, e.g., distraction. Moreover, different types of distraction could lead to different parameters or structure (Ljung, L., 1987). Another approach to detect the condition changes is to develop a model for a specific condition, i.e., baseline condition, and then assess changes in model performance when data from different conditions is used as an input into the model.

This study examines the hypothesis that the model defined for non-distracted driving will change its performance when data from distracted driving is used as an input into this model. The overall process of eye-steering models

development and using these models for driver state identification is presented on Figure 27. The data of the same driver distracted driving (step1) and to data of non-distracted and distracted driving from other drivers (step 2) are applied to models derived for each driver. Models performance is evaluated through *Best Fit* values. These *Best Fit* values are examined on their ability to identify presence of distraction, i.e., driver distracted condition.

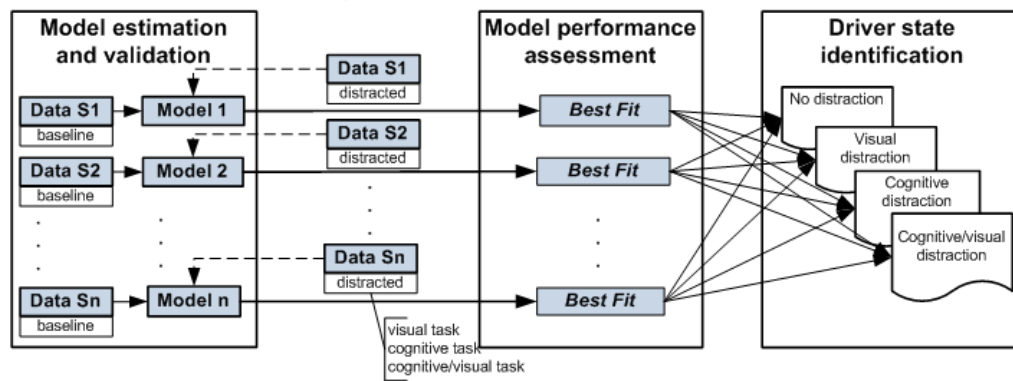

Figure 27. Schema of model development and driver state identification through model performance for a single driver (step 1). Step 2, when the data of non-distracted and distracted driving from all the drivers are applied to each model, is not shown on the schema

For the models development, the pre-treated datasets (see *Data pre-treatment* section) from 12 drivers are divided on 30-second non-overlapping segments. For each driver, two different segments from baseline driving that do not contain off-road glances are used for the model estimation and validation. For this purpose, all the segments from baseline driving are examined on presence of off-road and unusual glances (Table 5). Four types of eye movement have been identified: at the road center (eye movement 2), at driving scene (eye movement 3); with presence of glances at instrument panel (the combination of eye

movement 3 and 4); and with presence of unusual for driving task glances (the combination of eye movement 3 and 6).

This classification was done to verify the hypothesis that the presence of any off-road glance, even driving related, e.g., at instrument panel, could influence model performance. As it was discussed in *Eye-steering correlation for eye movement types* section, the eye-steering relationship varies when a driver looks at the road from looking off the road. While looking at the road ahead, drivers get information about driving environment and this information contributes the vehicle control, e.g., steering. This eye-steering coordination is very strong on curvy roads because eyes follow road curvature to guide steering (Land, 2006). However, while driving on a straight road, even with on-road glances, this relationship is not expected to be as strong as it was obtained on curvy roads, i.e., eye movements do not “force” steering movements. Off-road glances are also likely to change this relationship and diminish eye-steering coordination. Thus, influence of driving related (i.e., at instrument panel) and non-driving related (at in-vehicle display) off-road glances will be tested.

Before models development, all the segments of data were examined for the presence of a non-zero trend, i.e., non-zero-slope straight line that best fits the data in the least squares sense. This was done to confirm the results of interrupted time series analysis and ensure that there was no need for trend modeling before system identification. Another reason for conducting trend test is verification that the changes in model performance, when data from distracted driving is used as an input into the model, are not caused by changes in slopes.

The trend test shows that the mean slope values for steering angle and horizontal eye position were very close to zero for all the distracted conditions. The slope values deviate from zero in a wider range for visual task ( $M=0.028$ ,  $SD=0.185$ ) and cognitive/visual task ( $M=0.031$ ,  $SD=0.311$ ) compared with

baseline ( $M=-0.002$ ,  $SD=0.039$ ) and cognitive task ( $M= -0.002$ ,  $SD=0.045$ ) conditions (Figure 28). These large deviations in slope values are caused by off-road glances associated with large angles.

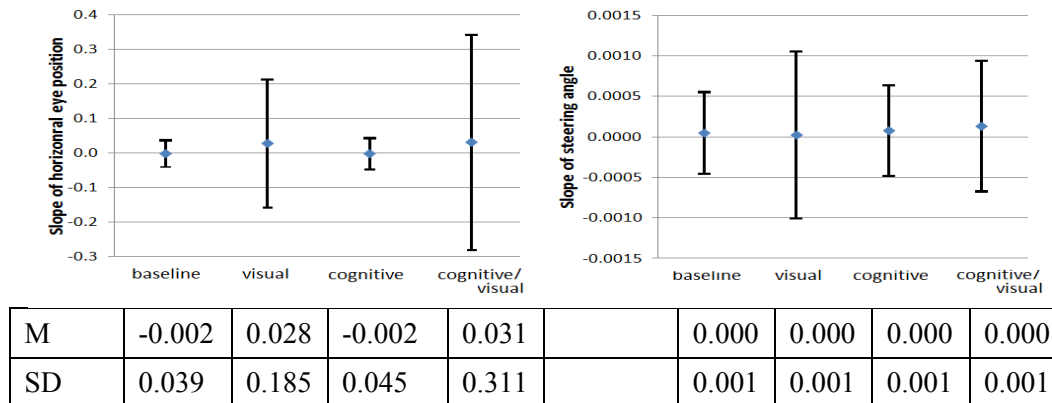

Figure 28. Slope statistics: mean values (with standard deviation bar) for non-distracted and distracted driving

Different combinations of these off-road glances and on-road glances in 30-second segments make negative, positive, and close to zero slopes (Figure 29). The presence of the slope and its direction depends on where the off-road glances occur: the negative slope is caused by the off-road glance at the beginning of the segment; positive – at the end; and zero – in the middle or at the both ends of a segment. Since, the off-road glance positioning is random, it could be concluded that slope is zero for all driving conditions. Therefore, for system identification, there is no necessity to model the trend before removing it.

Thus, before system modeling, the segments of data were detrended to remove means and any possible trend. As a part of signal preprocessing, the time series segments were filtered to remove high frequency component associated with saccades and noise (Figure 30).

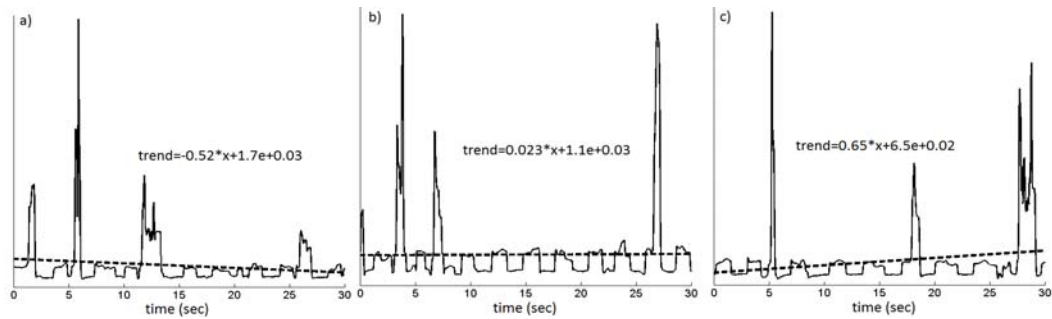

Figure 29. Trend information for 30-second segments of driving with visual task:  
a) negative slope; b) zero slope; c) positive slope

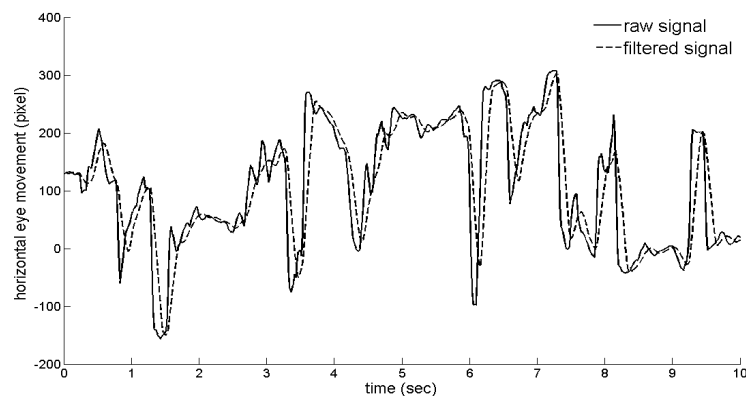

Figure 30. Comparison of a raw and filtered eye movement signal

For the models development, the Matlab (R2010a) System Identification Toolbox Software (version 7.4) is used. Different sets of model structure (ARX, ARMAX, and non-linear), number of previous input and output, and time delays are examined to identify the best fitting model for each driver. The models are validated by the following criteria: (1) minimum value of FPE; (2) models should pass whiteness and the independence tests (see *Model validation* section); and (3) if more than one model passed criteria (1) and (2), the model with a minimum order is chosen.

Based on these criteria, an example of the model selection process for Subject 1 is presented on Figure 31. The models with lower order (arx2174 and arx6174) did not meet criterion (2) – they did not pass whiteness and the independence tests (Figure 31, b). For two other models (arx81171 and arx8174), the *Best Fit* and FPE values were very close; and the preference was given to the model with the smaller time delay. The consideration of the noise term (ARMAX structure) and non-linear structure did not improve model performance.

The models are identified for all the subjects through the same procedure. The chosen models have some similarity: all the models have ARX structure, i.e. non-linearity and noise modeling (MA component) did not improve model performance; the number of previous inputs ( $n_b$ ) is 1; and in most cases, the number of previous outputs ( $n_a$ ) is 8 (M=8; SD=1). The number of input samples ( $n_k$ ) that occur before the input that affects the output is in the range from 66 to 98 (M=78; SD=11).

The model uncertainty is evaluated through variability of estimated model parameters – means and standard deviations of coefficients generated by toolbox algorithm. These measures can be used to compare the derived models across the drivers. Assuming that the coefficients of a single model are from the normal distribution with these ARX-generated means and standard deviations (Table 12), the coefficients are compared across the models and assessed by the degree of the confidence intervals overlap. If the coefficient confidence intervals from different models overlap, then the parameters can be considered from the same distribution (Figure 32).



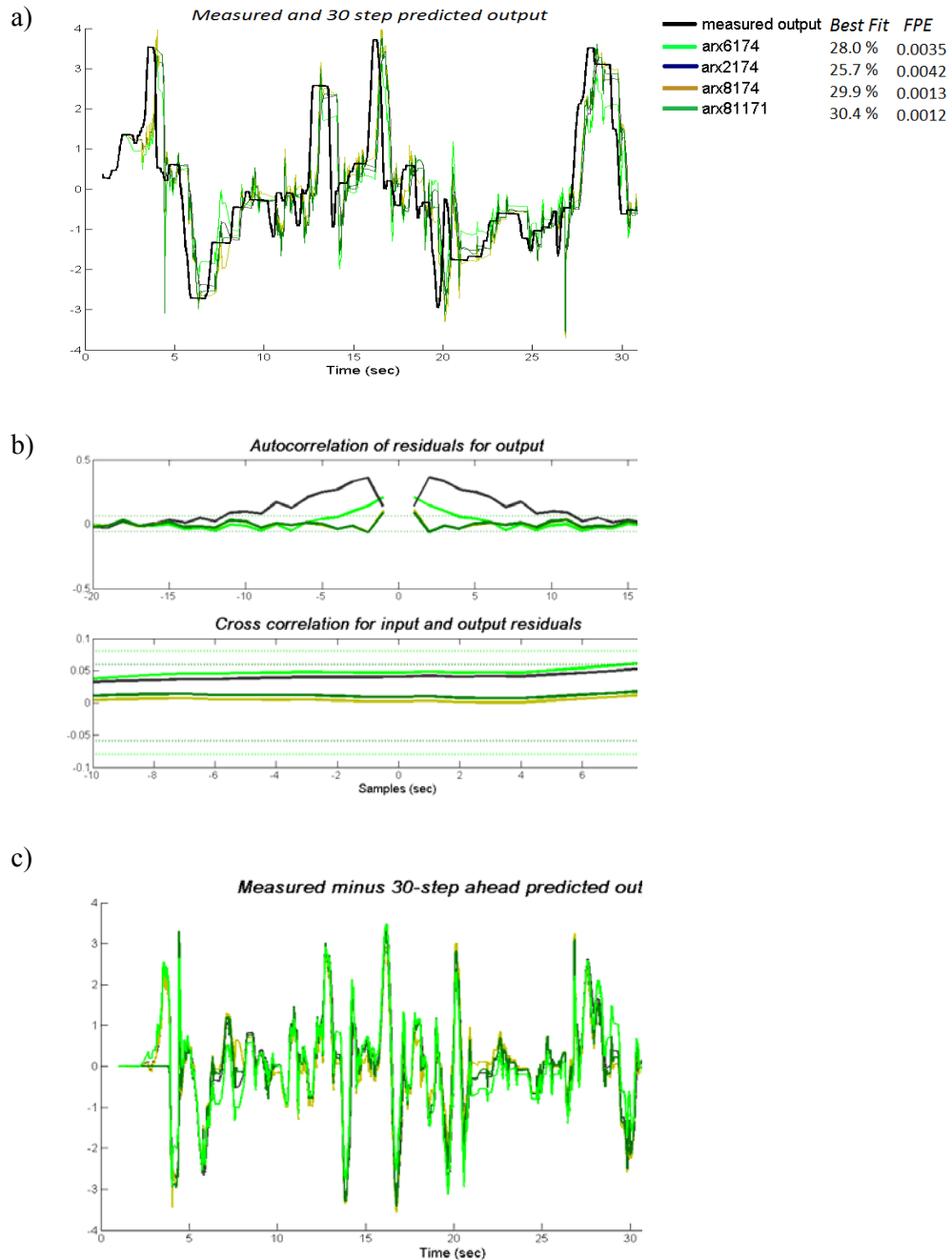

Figure 31. Comparison of candidate models for non-distracted driving of Subject 1: a) 30 steps ahead predicted and measured output comparison; b) auto- and cross- correlation for residuals (the horizontal scale is the number of lags (samples) between the signals at which the correlation is estimated); and c) residuals (error)

This comparison is done for the first seven coefficients of the parameter A ( $a_1$ -  $a_7$ ) and for a single coefficient of the parameter B ( $b_{nk}$ ). These graphs show that the distributions overlap for  $a_5$ ,  $a_6$ , and  $a_7$ ; they partially overlap for  $a_2$ ,  $a_4$ , and  $b_{nk}$ ; and the least overlap is for  $a_1$  and  $a_3$ . This variability in the models' parameters is most likely due to variations in driving style among the drivers.

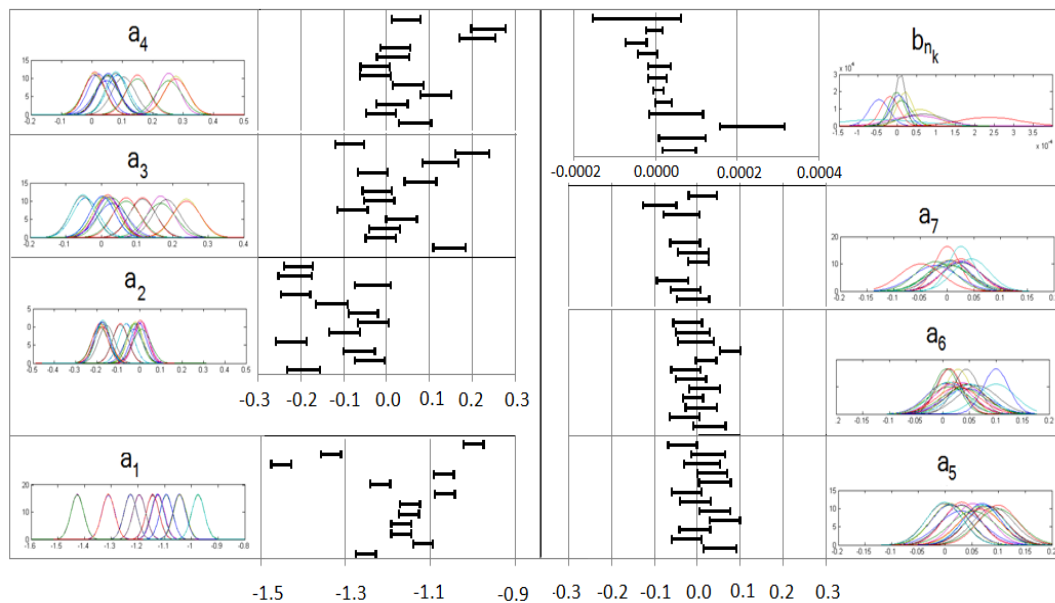

Figure 32. Model parameters variation histogram and confidence intervals across the subjects

To assess whether model performance, measured through *Best Fit* value (9), can identify distracted driving, the models are applied to 30-second segments of data from different distracted conditions, i.e., non-distracted and three types of distracted conditions. First, data from the same driver based on which the model has been developed is used. The *Best Fit* values compared 30 steps ahead predicted by the model output with measured output for each segment of data. These values

are compared through a within-subject ANOVA with repeated measures using SAS 9.2 PROC MIXED procedure.

Table 12. Summary of the chosen models. The model structure is defined through number of previous inputs  $n_b$ , previous outputs  $n_a$ , and delayed inputs  $n_k$ . Standard deviations of the coefficients are in curly brackets for  $a_1$ - $a_{n_a}$  and  $b_{n_k}$

Model	Model structure			FPE	Parameters	
	$n_a$	$n_b$	$n_k$		A	B
m1	8	1	74	0.001	[-1.228;-0.155;0.183;0.104;0.090;0.065;0.027;-0.086] {0.024;0.038;0.038;0.038;0.038;0.038;0.038;0.024}	0.000058 {0.000041}
m2	9	1	67	0.019	[-1.094;-0.005;0.021;0.022;0.01;0.005;0.008;0.015;0.023] {0.024;0.036;0.036;0.036;0.036;0.036;0.036;0.036;0.024}	0.000066 {0.000057}
m4	8	1	74	0.006	[-1.145;-0.027;0.031;0.049;0.030;0.045;-0.022;-0.071] {0.024;0.037;0.037;0.037;0.037;0.037;0.037;0.024}	-0.000047 {0.000079}
m5	6	1	69	0.001	[-1.145 -0.186;0.070;0.150;0.099;0.013] {0.024;0.036; 0.036; 0.036; 0.036; 0.024}	-0.000002 {0.000066}
m7	7	1	80	0.004	[-1.127;-0.062;-0.044;0.085;0.075;0.052;0.026] {0.024;0.036;0.036;0.036;0.036;0.036;0.024}	0.000237 {0.000020}
m8	8	1	66	0.007	[-1.125;0.004;0.018;0.010;0.031;0.020;0.026; 0.020] {0.024;0.036;0.036;0.036;0.036;0.036;0.036;0.024}	-0.000045 {0.000013}
m9	8	1	76	0.034	[-1.043;-0.020;0.012;0.008;0.009;0.007;0.006;0.033] {0.024;0.035;0.035;0.035;0.035;0.035;0.035;0.024}	0.000050 {0.000022}
m10	6	1	97	0.003	[-1.195;-0.090;0.116;0.052;0.077;0.044] {0.024;0.038;0.038;0.038;0.038;0.024}	0.000020 {0.000027}
m11	6	1	87	0.002	[-1.045;-0.178; 0.003;0.054;0.069;0.100] {0.024;0.035;0.035;0.035;0.035;0.024}	0.000008 {0.000023}
m13	8	1	98	0.002	[-1.427; 0.010; 0.167;0.253;0.052; 0.038;0.005;-0.096] {0.024;0.042;0.042;0.043;0.043; 0.042; 0.042;0.024}	0.000004 {0.000026}
m14	8	1	75	0.002	[-1.311;-0.173;0.239;0.276;0.065;0.029;-0.049;-0.071] {0.024;0.040; 0.040; 0.040; 0.040; 0.040;0.040;0.024}	0.000010 {0.000020}
m15	8	1	76	0.004	[-0.975;-0.172;-0.052;0.079; 0.001;0.011;0.045;0.069] {0.024;0.034;0.034; 0.034; 0.034; 0.034; 0.034; 0.024}	-0.000019 {0.000108}

The models performance is evaluated for different segments of baseline data classified according to the eye movement type (Table 5). The *Best Fit* values are compared for model order defined as a number of previous inputs and previous outputs, time delay between input and output (delayed input), and type of eye movement. There is no significant effect of the model order ( $F(1,9)=3.19, p=0.41$ ) and number of delayed inputs ( $F(1,9)=0.99, p=0.54$ ). The result that the models of different orders performed equally well indicates the difference in driving behavior: the more complex driving behavior is described by more complex model.

Different time delay between input and output might also differentiate driver state. Since the each driving session was divided on segments, the sequence of segments was examined; and it has no effect ( $F(9,64)=0.74, p=0.67$ ) on *Best Fit* values. This is an expected result because there was no obvious reason for changing driving behavior (visual or steering): driving environment has not been changed and driving sessions were too short to cause, for example, fatigue.

Another expected result is that the eye movement type, defined for baseline driving through the combination of on-road and off-road glances (Table 5), influences the model performance ( $F(3,18)=3.63, p=0.03$ ). Pair-wise comparisons using the Tukey test show that driving related off-road glances (at instrument panel) significantly reduce the *Best Fit* values: at road center ( $M=36.49, SD=8.01$ ) vs. at instrument panel glances ( $M=26.29, SD=6.65$ ),  $t(18)=2.44, p=0.02$ ; at driving scene ( $M=37.25, SD=6.77$ ) vs. at instrument panel glances ( $M=26.29, SD=6.65$ ),  $t(18)=3.2, p=0.005$ ) (Figure 33, a). On the other hand, the presence of the glances unusual for a driving task ( $M=32.14, SD=6.51$ ) does not affect the model performance significantly (at road center vs. unusual glances,  $t(18)=1.11, p=0.28$ ; at driving scene vs. unusual glances,  $t(18)=1.69, p=0.11$ ). The difference between unusual glances and glances at instrument panel is marginally significant

( $t(18)=1.78, p=0.09$ ). Because, the focus of these glance is unknown, it is hard to explain these results. In sum, the results indicate that some, even driving related, off-road glances (i.e., at instrument panel) can be identified by the models derived from the segments with on-road glances.

The analysis of models' performance is carried out for all the driving conditions. It shows that the *Best Fit* values are higher for baseline and cognitive driving conditions than for visual and cognitive/visual ones (Figure 33, b). The Levene's test for homogeneity shows that the variances differ from each other, i.e., heterogeneous ( $F(3,44)=2.93, p=0.04$ ). The Welch's test that accounts the inequality of variances shows that distracted condition has a statistically significant effect on model performance ( $F(3,23.6)=13.33, p<.0001$ ). Between-subject factor of gender is not statistically significant for model performance across all three conditions ( $F(1,10)=0.56, p=0.47$ ).

Post-hoc comparisons using the Tukey HSD test indicates that the *Best Fit* value for the visual condition ( $M=5.87; SD=20.21$ ) is significantly different from the baseline condition ( $M=32.53; SD=12.32$ ) and cognitive task condition ( $M = 29.33, SD = 13.64$ ) but not for cognitive/visual, ( $M=7.74, SD=25.44$ ). The *Best Fit* for cognitive condition does not significantly differ from the baseline condition. These results support the hypothesis that the model defined for baseline driving can identify distracted driving.

When the data from all the subjects is used as an input into each model from Table 12, the mean values decreased slightly across all the conditions (Figure 34). The standard deviations decreased substantially for baseline and cognitive conditions and slightly for visual and cognitive/visual conditions.

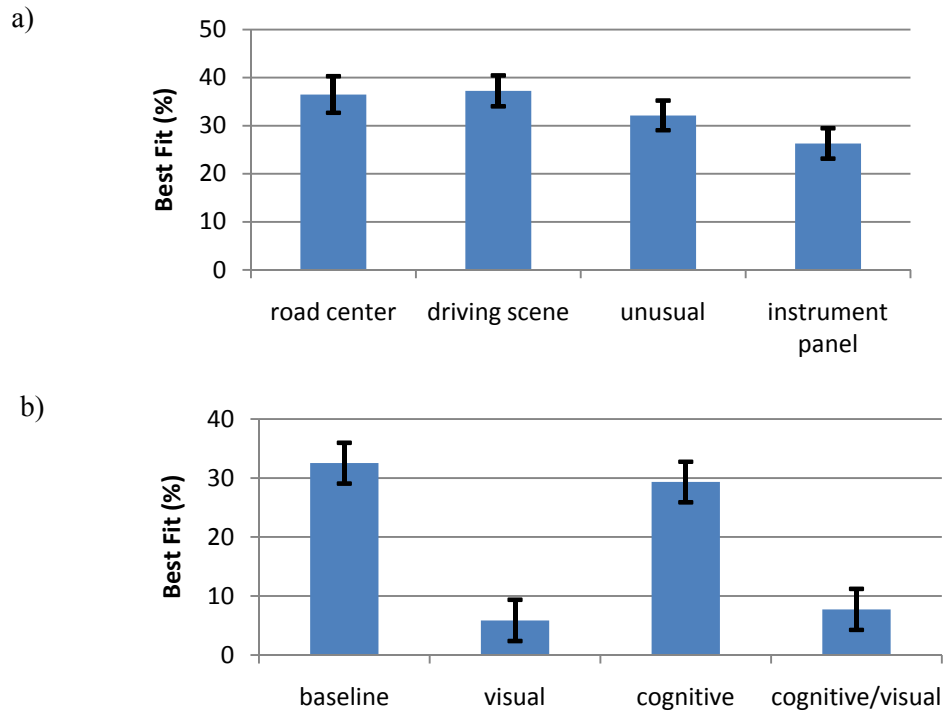

Figure 33. Model performance for (a) types of eye movement of baseline condition and (b) distracted conditions

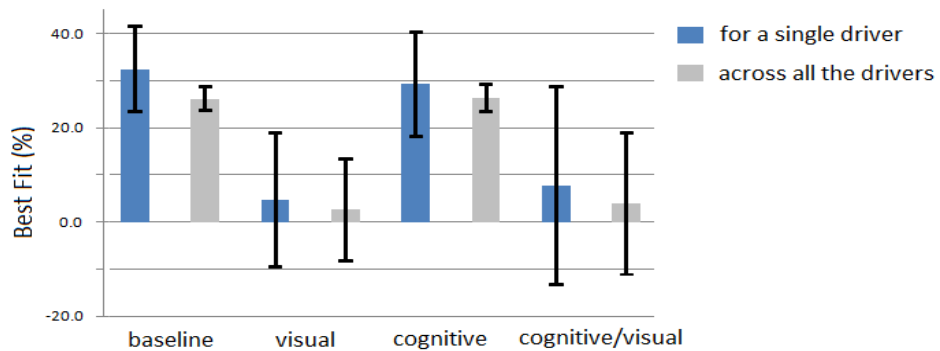

Figure 34. *Best Fit* values (with standard deviation bar) for non-distracted and distracted conditions

An example of changes in model performance with distracted condition is on Figure 35: the model fit values decrease when the models are applied to data of visual task condition compared to baseline condition.

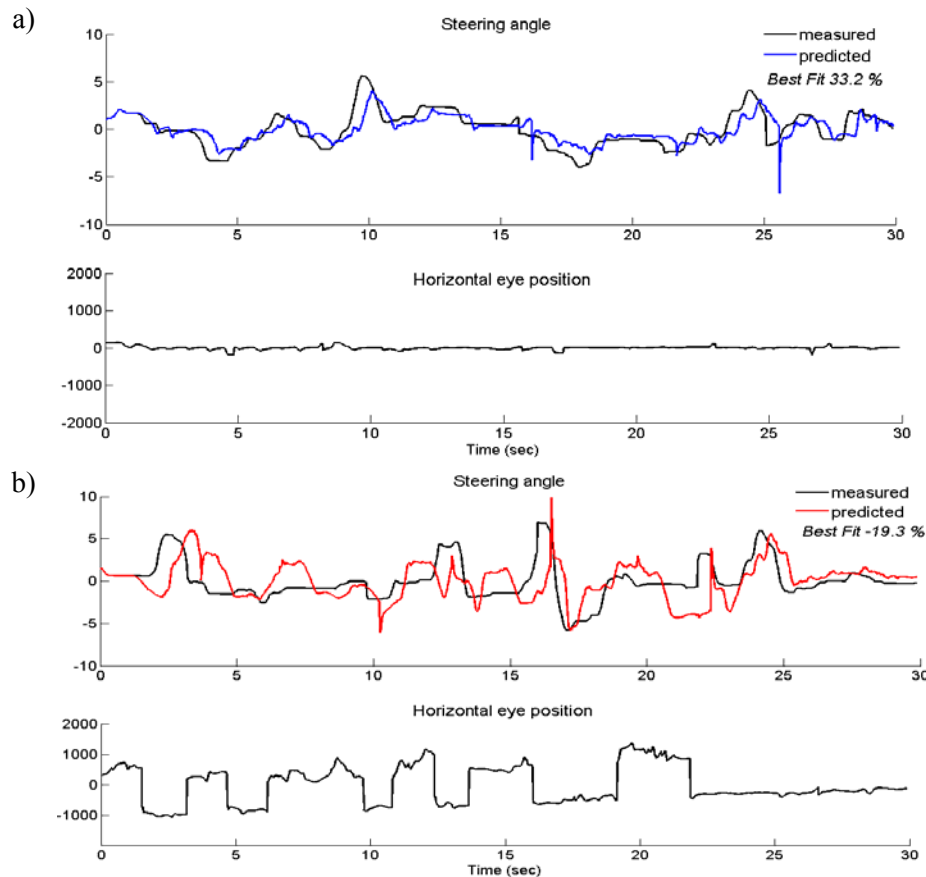

Figure 35. Measured and 30 steps ahead predicted by the model m4 output for (a) baseline condition and (b) visually distracted condition. Negative value of *Best Fit* indicates that estimation algorithm failed to converge

To examine the models ability to differentiate distracted driving from non-distracted driving, the classification cost/benefit analysis was performed. The receiver operating characteristic (ROC) – relationship between the hit rate and the false alarm rate – is plotted. As cut-off points, 15, 25, 50 and 75-percentiles of the *Best Fit* values of baseline driving from all the subjects are used (Figure 36). The

distributions for baseline and cognitive conditions almost coincide, making classification inaccurate.

This analysis shows that all the models failed to differentiate cognitive distraction from baseline condition – the classification is no better than random guessing (Figure 37). The differentiation of visual distraction from baseline condition was the most accurate; and there was some similarity in models' performance. For cognitive/visual distraction, the models' ability to differentiate conditions varied and was less accurate than for visual distraction. Among the models, the one that most successfully differentiates visual and cognitive/visual distraction is m4 (arx8174) (Figure 38). For this comparison, the 25-percentile cut-off point is used.

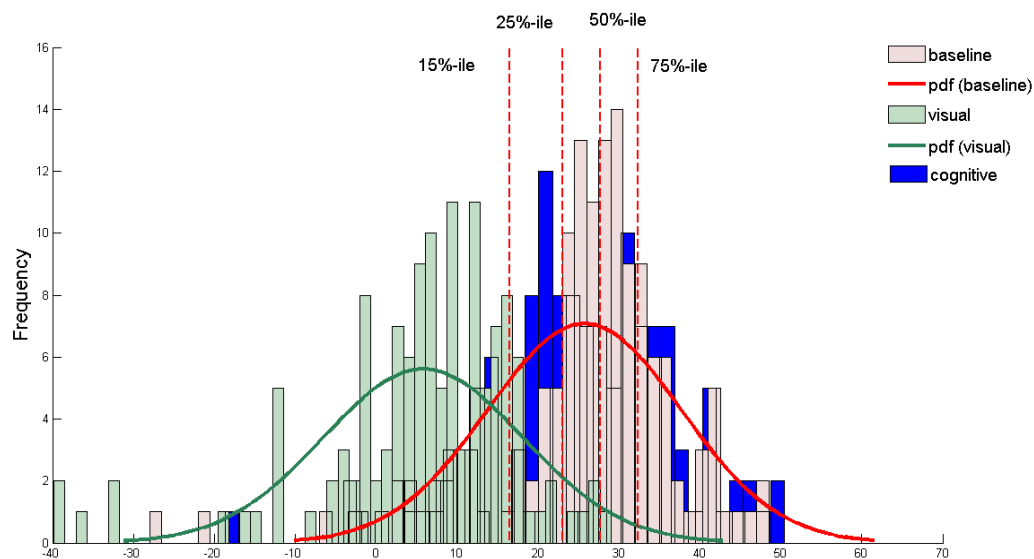

Figure 36. Distributions of the Best Fit for non-distracted, visually distracted, and cognitively distracted conditions and cut-off points. The probability density functions (pdf) for cognitive condition almost coincide with the pdf for baseline condition and is not shown on the graph



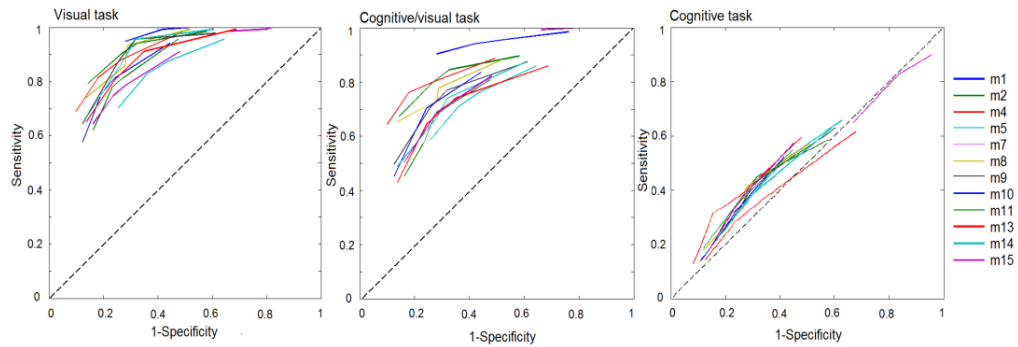

Figure 37. ROC curves. Cut-off points are defined as 15, 25, 50 and 75-percentiles of the *Best Fit* values (baseline condition)

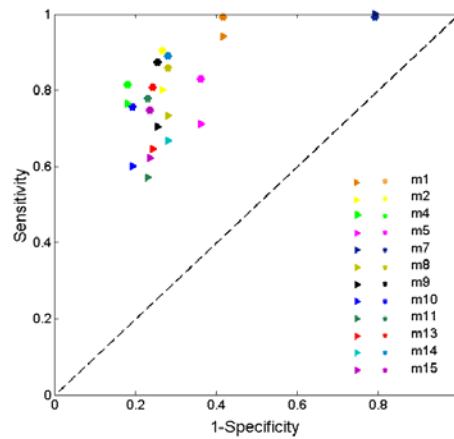

Figure 38. Models' comparison on their ability to detect distraction: triangles – for visual distraction and stars – for cognitive/visual distraction

### Conclusion

This chapter presents efforts in developing an eye-steering model. This study tests the hypothesis that eye-steering system defined for baseline (non-distracted) condition will result in different model fit when data from distracted conditions are used as an input to this system. According to this hypothesis, such a model can differentiate distracted driving.

The underlying theory of this hypothesis is Land's visual information and control framework. It suggests that on curvy roads gaze horizontal position is systematically coupled to roadway curvature and guides the steering movements, i.e., eye-steering coordination is strong (Land, 2006). Driver impairment might diminish this coordination. The change in coordination and associated change in model fit might accurately indicate cognitive and visual distraction.

In this assessment, it is critical to apply models derived for non-distracted driving for situations that involve glances away from the road, such as instances of visual distraction associated with off-road glances. Cognitive distraction could also diminish this coordination. These glances represent a very different type of eye movement relative to lane keeping control. When glances are directed away from the road, the relationship between eye position and steering wheel position no longer holds. The visual information input becomes zero with any off-road glance causing reduced steering output. Returning glance back to the road provokes steering output. Thus, the system defined for non-distracted driving associated with glances at driving scene will be affected by any off-road glance.

It should be mentioned that curvy roads place a greater demand on driver eyes to guide steering and make "input" stronger than straight roads do. The eye-steering relationship on straight roads is qualitatively and quantitatively different from the one observed on curvy roads: drivers scan the road to be aware of the driving situation and less frequently to guide their steering. Although eye-steering correlation is weak, a presence of any distraction can affect this eye-steering relationship.

To confirm the hypothesis that eye-steering system can differentiate distracted driving from non-distracted, the system identification approach is applied to define a model for each driver with horizontal eye position as an input and steering angle as an output. All the derived models have ARX model structure.

The number of previous inputs ( $n_b$ ) is one for all the models. In most cases, the number of previous outputs ( $n_a$ ) is eight indicating that current steering wheel angle depends on previous positions up to 0.13 seconds. Based on this, the model order might decrease with re-sampling the signals to the lower rate. This reduction can be considered because both steering and eye movement signals have much lower than 60 Hz fundamental frequency – less than 1Hz (see section *Signal length and sampling*).

The number of previous outputs ( $n_a$ ) and time-delay between input and output ( $n_k$ ) vary across the drivers without affecting model performance. The result that the model complexity (i.e., order) does not affect model performance indicates the variability in driving behavior: the more complex model is associated with more complex driving behavior. Another support for variability in driving behavior is that some models' coefficients are similar (belong to the same distribution) but others are not.

To examine the fit of the models across drivers, the data from other drivers was used as an input into each model. Models' performance changed very little indicating that the models can perform in the same way as it was for a single driver (Figure 34). Two results that one model can fit to the data from other subjects reasonably well and that some model coefficients are from the same distribution leads to the suggestion that the model with the same structure and model order can fit to the data equally well if the particular parameters fit to individual drivers.

Attempts to select a single model that can provide a reasonable fit to the data from all the drivers led to the selection of the m4 model (arx8174):  

$$y(t) + -1.145y(t - 1) - 0.027y(t - 2) + 0.031y(t - 3) + 0.049y(t - 4) + 0.0e30y(t - 5) + 0.045y(t - 6) - 0.022y(t - 7) - 0.071y(t - 8) = -0.000047u(t - 74) + e(t)$$
. This model can differentiate visual and cognitive/visual distractions relatively successfully (Figure 38).

As was expected, off-road glances affect models' performance. The models performed worse with the presence of large-angle off-road glances (i.e., at in-vehicle display) during visual and cognitive/visual tasks. During baseline driving sessions, drivers exhibited different visual behavior: some drivers concentrated their glances at the road ahead and the driving scene; others moved eyes toward instrument panel and locations unexpected for driving task (classified as unusual glances). The presence of glances to instrument panel diminished model performance significantly. This result could mean that eye movement in vertical direction can also affect model performance.

The expectation that changes in relationship between eye and steering movements caused by cognitive distraction would affect the model performance is not confirmed. This expectation was based on sensitivity of time delay between eye and steering movement to cognitive task. Cognitive distraction did not significantly affect the model fit compared with non-distracted driving. This could be explained by two reasons. First, from the correlation analysis, the time delay between eye and steering movements was changed with cognitive distraction but the correlation coefficient was not. This causes the model to be less sensitive to changes in cognitive state of a driver than that is for visual distraction when both time delay and correlation coefficient vary. Second, as it was mentioned previously, the eye-steering relationship was not expected to be very strong on straight roads as it was obtained on curvy roads. Thus, the possible slight changes in this relationship associated with cognitive distraction do not affect model fit. Overall, based on the model performance, it was possible to identify visual and cognitive/visual distraction associated with off-road glances.

## CHAPTER 5. ESTIMATION OF THE INDIRECT EFFECT OF DISTRACTION ON VEHICLE STATE

The impact of distraction on driver performance, as measured by lane position, might be modulated by the eye-steering coordination. To examine the effect of driver distraction on vehicle state, the relationship between distracted condition as an independent variable and lane position as a dependent variable is modeled by considering the eye-steering correlation. In the causal *eye – steering – lane position* model, an assessment of the relationship between eye-steering correlation and lane position will be an important step in defining a prospective indicator of vehicle state. This prediction can help in minimizing crash risk caused by large deviation from centerline by alerting the driver before or on early in the process of lane departure.

In intervention studies when a hypothesis about a cause-and-effect relationship is tested, inclusion of a mediator or moderator can elicit information about why or how a direct association occurs between an independent variable and a dependent variable (Bennett, 2000). A mediator or moderator is a third variable that can change the association between them (Baron and Kenny, 1986). The mediator is usually considered when the relationship between the independent and the dependent variables is statistically significant; inclusion of the mediator helps to reveal the reasons for this association. When the association between the independent variable and the outcome variable is weak or inconsistent, a moderator can reveal the circumstances that strengthen or weaken the association. Inclusion of a mediator or moderator effect requires different statistical analyses.

### Analysis method

A moderator could be a qualitative or quantitative variable that affects the relation between independent and dependent variables. The model with moderator

considers three interactions with the dependent variable (i.e., lane position) (Figure 39): the impact of the independent variable (i.e., distracted condition) (path a), the impact of a moderator (i.e., eye-steering correlation) (path b), and the interaction of these two (path c) (Baron and Kenny, 1986). The moderator hypothesis is supported if the interaction (path c) is significant. To provide a clearly interpretable interaction term, it is desirable that the moderator variable be uncorrelated with both the independent and dependent variables. The moderator has the same level of causality as the independent variable in regard to its impact on the dependent variable, whereas mediating events shift roles from effects to causes. A mediator reflects the internal property of the subject being studied and it is a mechanism that elaborates the meaning of the relationship between the independent variable and the outcome variable.

Mediator inclusion can describe the relationship between independent and dependent variables more precisely. It can explain how or why the independent variable predicts the outcome (Baron and Kenny, 1986). The mediator inclusion should be supported by the assumption that the dependent variable does not predict the mediator variable. Considering the correlation coefficient as a mediator, the following conditions should be tested: the independent variable is a significant predictor of the dependent variable (lane position) (path a); the independent variable (distracted condition) is a significant predictor of the mediator (path b), and both the independent variable and mediator affect the dependent variable (lane position) (path c) (Figure 40). To check these three conditions, three regression models should be estimated:

$$\begin{aligned}
 D &= e_1 + aI \\
 M &= e_2 + bI \\
 D &= e_3 + a'I + cM
 \end{aligned}
 \tag{10}$$

If all these conditions are met, the effect of the independent variable on the dependent variable must be less in the third equation than in the first one. The mediation would be considered perfect if the independent variable has no effect on the dependent variable when the mediator is controlled. The mediation testing strategy requires (1) the independent variable affects the dependent variable ( $a \neq 0$ ); (2) the existence of an effect of independent variable on mediator ( $b \neq 0$ ); and (3) the indirect effect to be statistically significant in the direction predicted by the mediation hypothesis, i.e. correlation coefficient affects driver performance measured through the lane position (Preacher and Hayes, 2004).

Since, the multicollinearity caused by correlation between mediator and independent variables leads to reduced power while testing the coefficients in the third equation, not only the significance of the coefficients but also their absolute size should be tested (Baron and Kenny, 1986). A Sobel test calculates the critical ratio to compare it with the critical value from the standard normal distribution for a given alpha level:

$$z - value = bc/s_{bc}$$

$$where \quad s_{bc} = \sqrt{c^2s_b^2 + b^2s_c^2 + s_b^2s_c^2}$$

is a standard error of the indirect effect,  $s_b$  and  $s_c$  are standard errors of the  $b$  and  $c$  coefficients respectively. Since, the term  $s_b^2s_c^2$  is usually small, it can be omitted. However, for the within-subject experiment design, there is no formal statistical test for mediation. The decision about mediation and moderation is based on the estimation of the effect of the independent variable on the dependent variable in the regression models mentioned above (Judd, Kenny et al., 2001).

To create the regression models, the cross-correlation coefficients and time delays between eye and steering signals calculated for the segments of non-distracted and distracted driving in Chapter 3 (Aim1) are used. The deviation from

the centerline calculated for each segment is examined on its sensitivity to distraction. Based on this dataset, the models with eye-steering correlation parameters (correlation coefficient and time delay) as a moderator and mediator are examined.

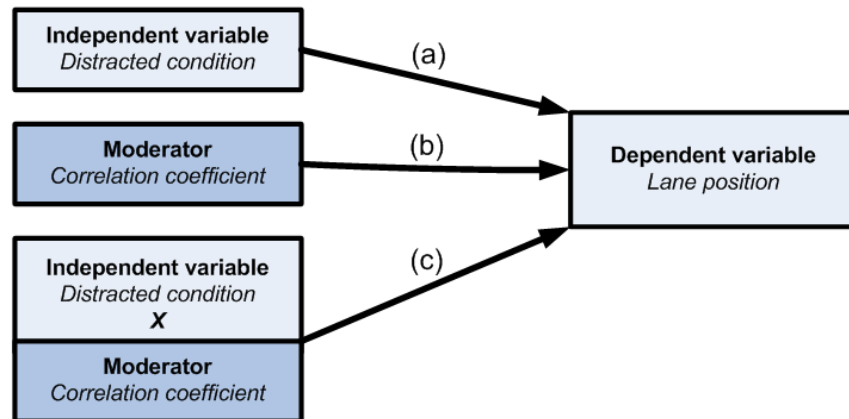

Figure 39. Model with moderator effect

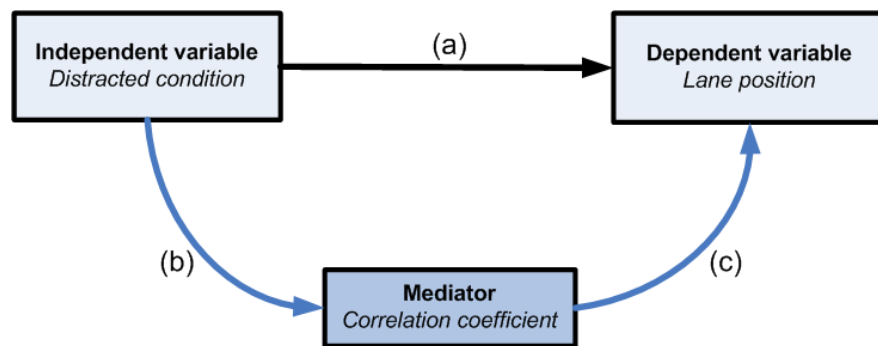

Figure 40. Model with mediator effect



### Results and discussion

Correlation parameters – correlation coefficient and time delay – are tested as being a moderator or a mediator in order to examine the role of eye-steering correlation in *distracted condition – lane position* relationship. The distracted condition is an independent variable that affects lane position as a dependent variable. It is expected that the eye-steering correlation coefficient or time delay (or even both) as an indicator of distraction can mediate changes in lane position. The correlation coefficient and/or time delay acting as a mediator will explain the causal relationship between distracted condition and lane position. If this hypothesis is confirmed, then the measure of eye-steering correlation could be considered as an indicator of lane position changes caused by the changes in distracted condition.

This hypothesis is tested through regression modeling. The correlation coefficient and time delay were calculated in Chapter 3 (Aim 1) for each 30-second segment of data from all the distracted conditions – non-distracted (baseline), visual task, cognitive task, and cognitive/visual task. As a measure of lane keeping performance in a given 30-second segment, the mean, 95 percentile, and maximum values of standard deviations calculated for 200 ms time windows were tested on being sensitive to correlation parameter changes. The maximum value and 95 percentile value of standard deviations had very similar results. Here, the maximum value of standard deviations (MaxSD) of lane position represents the results of the analysis.

To verify if correlation parameters mediate the lane position, three regression models (10) are considered by using SAS 9.2 PROC MIXED. The first equation tests if the distracted condition significantly predicts the MaxSD of lane position. The second equation tests if the distracted condition significantly predicts the mediator, i.e., correlation coefficient or time delay. In the third equation, both

distracted condition and the mediator are considered to predict MaxSD of lane position. Mediation will be established if (1) the first and the second equations are shown to be significant; and (2) in the third equation, the mediator significantly predicts lane position. The inclusion of the interaction term in the third equation assesses the correlation parameters as moderators.

Two models test the moderation effect of correlation coefficient or time delay on MaxSD of lane position. In the first model, MaxSD of lane position is regressed on correlation coefficient, distracted condition, and the interaction term of these two variables. The regression model of the same structure is built for time delay. The results do not reveal any moderator effect for time delay: the interaction term does not significantly affect the dependent variable (Table 13). For the correlation coefficient, the interaction term is marginally significant. This implies that the eye-steering correlation parameters do not significantly influence the strength of the relationship between distracted condition and lane position.

While testing mediation, the first and second regression models meet criterion (1) – distracted condition significantly predicts MaxSD of lane position and correlation parameters (Table 13). The analysis of the third equation, that involves both the mediator and distracted condition as independent variables, indicates that the time delay significantly affects MaxSD of lane position – criterion (2), but correlation coefficient – does not.

Thus, it could be concluded that variations in time delay between eye and steering movements mediate changes in vehicle state. Because the relationship between distracted condition and lane position in the third equation has not been reduced as compared to the first equation, the mediation is not perfect, i.e., it is partial (Baron and Kenny, 1986).

Table 13. Regression models analysis summary

Model	Mediator/ moderator	Variable	DF	F value	p-value
Mediator analysis					
$D = e_1 + aI$		I	3,32	78.03	<.0001
$M = e_2 + bI$	CC	M	3,32	9.18	0.0002
	TD	M	3,32	9.33	<.0001
$D = e_3 + a'I + cM$	CC	I	3,32	74.76	<.0001
		M	1,448	0.36	0.55
	TD	I	3,32	77.50	<.0001
		M	1,448	5.42	0.02
Moderator analysis					
$D = e + aI + bM + cI * M$	CC	I	3,32	9.25	<.0001
		M	1,445	0.15	0.69
		I*M	3,445	2.41	0.07
	TD	I	3,32	36.77	<.0001
		M	1,445	4.12	0.04
		I*M	3,445	1.42	0.24

I – distracted condition; M – mediator or moderator; I\*M – interaction term; CC - correlation coefficient; TD – time delay

### Lane departures

The main results from this study are that (1) eye-steering model is sensitive to off-road glances; (2) the changes in model performance are caused by changes in correlation parameters, particularly by time delay; and (3) time delay mediates changes in lane position. These results might assume that the eye-steering system can be sensitive to breakdowns in lane keeping as well, i.e., it can predict lane departures.

It is assumed that lane departures are the consequence of dangerous levels of distraction. Liang (2009) indicated that visual distraction severely impairs vehicle lateral control. That study defined the lane departure event as crossing the

lane boundary by any part of the vehicle. This corresponds to a deviation from the lane center of more than 1.06 meters. Based on this definition, the frequency of lane departures ranged from 89 (10 drivers out of 12) to 24 (5 drivers out of 12) during visual and cognitive/visual distractions respectively. The frequency of lane departures across the drivers is not evenly distributed: some drivers consistently crossed the lane (up to 36 times); others had a few lane departures (from 1 to 9 times); and two drivers did not experience lane departures in any conditions. The lane departures were not observed for baseline condition and only one lane departure occurred during cognitive distraction.

To assess whether the eye-steering model defined for baseline driving can differentiate the segments with lane departures from the segments without it, three groups of segments are considered. Two groups of segments with and without lane departures are from visually distracted condition and the third group of segments represents baseline driving (Figure 41). For this comparison, the data from drivers that departed the lane several times but not consistently (e.g., 36 times) were considered. Two drivers that did not experience any lane departure are not considered either. Thus, the data from eight drivers is used for this analysis.

The length of the selected segments is six seconds. The segments with lane departure include five seconds before and one second after the lane departure (Klauer, Dingus et al., 2006; Liang, 2009). For visually distracted condition, the interval between the segments with lane departure and without it is at least six seconds. For the third baseline group, the segments are randomly chosen from the same eight drivers. The number of the segments in each group is equal. Model m4 is used in this analysis because its performance was considered as the best among all models (see section *Results and discussion* from Chapter 4).

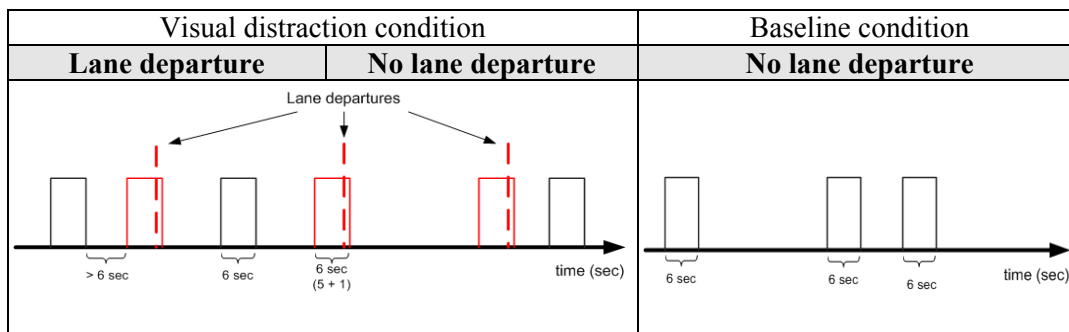

Figure 41. Three groups of segments with and without lane departures

The sensitivity of the model to lane departures is tested through the *Best Fit* measure. The comparison of the *Best Fit* values for these three groups is done in SAS 9.2 using PROC MIXED. The results show that there is a significant difference between three groups ( $F(2,14) = 8.50, p=0.004$ ): for “lane departure” group,  $M=13.74, SD =21.15$ ; for visually distracted “no lane departure” group,  $M=8.57, SD =21.38$ ; and for baseline condition “no lane departure” group,  $M=27.77, SD=18.71$ . The post-hoc comparisons with Tukey HSD test indicates significant difference between baseline “no lane departure” and visual “no lane departure” groups ( $t(14)=2.92, p=0.01$ ) and between baseline “no lane departure” and “lane departure” groups ( $t(14)=3.99, p=0.001$ ). However, the difference between “lane departure” and visual “no lane departure” groups was not significant ( $t(14)=1.09, p=0.30$ ).

Because dangerously distracted condition that could cause lane departures is mostly associated with visual distraction, this result might indicate that (1) visual behavior does not differ for two groups with and without lane departures or (2) the model is not sensitive enough to off-road glances that could impact safety. To examine the former assumption, the percent of off-road glances in six-second segments is calculated. The difference in percent of off-road glances for these two

groups is not significant ( $t(34)=1.63, p=0.11$ ): for “lane departure”,  $M= 64.58, SD = 20.74$ ; and “no lane departure”,  $M=58.31, SD=23.91$ .

This result might indicate that driver visual behavior is not the only reason of lane-keeping performance degradation. Pohl et al. (2007) mentioned that there are many reasons for poor lane-keeping behavior, e.g., simply bad driving habits, such as task prioritization and choice of safety margins. Horrey et al. (2006) showed how task prioritizing affects visual scanning behavior and lane keeping. While performing a visual task, lane keeping was improved when drivers were concentrated on driving task and degraded with concentration only on the secondary task. Such a driving behavior associated with task prioritization might affect length and frequency of glances but not the percent of off-road glances. This might explain non-significant difference in off-road glances percent and model fit between “lane departure” and “no lane departure” groups. In addition, this driving behavior might be a primary reason of different frequencies of lane departures across the drivers.

An interesting observation that could support this assumption is made when visual behavior of two drivers who did not experience any lane departure was compared with visual behavior of two drivers that consistently crossed the lane. The percent of off-road glances was almost the same for these two driving behaviors: without lane departures, 48.78 and 57.44 and with lane departures, 48.55 and 58.30.

Another aspect to consider in the *visual behavior – lane position* relationship is the role of ambient vision. Horrey et al., (2006) investigated the degree to which focal vision is responsible for visual scanning and for task performance. The lane-keeping task was less dependent on the focal vision; it relied on the ambient vision. The ambient vision can directly support vehicle control without requiring an eye movement and fixating directly on the outside

world. This finding can also explain the results of this study when eye-steering model was not sensitive to lane departures.

To assess whether the model is sensitive to off-road glances that could impact safety, the residuals were examined. Residuals represent the portion of data not explained by the model and are calculated as difference between the predicted output from the model and the measured output. The model-checking techniques suggested by Lin, Wei, et al., (2002) is based on residuals comparison. This technique assumes that each observed process could be compared with another one, both graphically and numerically, through cumulative sum of residuals. For example, trends of plotted cumulative sum of residuals could reflect differences in model fit when models with different structures are compared. The trend could change when different sets of data are used as an input into to the same model. These changes could indicate different conditions.

Thus, the residuals for two groups of segments with and without lane departures are plotted (Figure 42). To compare these two groups, sum of residuals' absolute values was calculated for each segment. This comparison shows that the group of segments with lane departure has larger sum of residuals values ( $M=40.4$ ,  $SD=20.2$ ) than the group of segments without lane departure does ( $M=26.7$ ,  $SD=13.3$ ) ( $t(34)=4.41$ ,  $p<.001$ ).

The cumulative sum of residuals is plotted for the segments from both groups (Figure 43, left graph). To compare these two groups, each curve is fitted with a linear model (Figure 43, left graph). The 95 percentile values are calculated as well. This comparison of 95 percentile values shows that the group with lane departures has significantly higher 95 percentile values ( $M=36.0$ ,  $SD = 18.2$ ) than the group without lane departures ( $M=24.6$ ,  $SD=12.3$ ) ( $t(34)=3.68$ ,  $p<.001$ ). The slope values of these two groups are significantly different as well ( $t(34)=3.07$ ,

$p=0.004$ ): for lane departure group,  $M=0.11$ ,  $SD=0.05$ ; and for no lane departure group,  $M=0.08$ ,  $SD = 0.04$ .

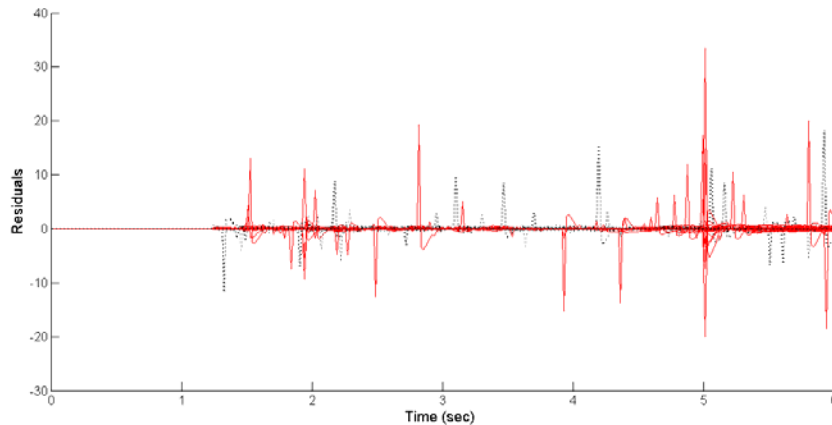

Figure 42. The residuals (predicted minus measured output) for two groups of segments with (red line) and without (black dotted line) lane departures

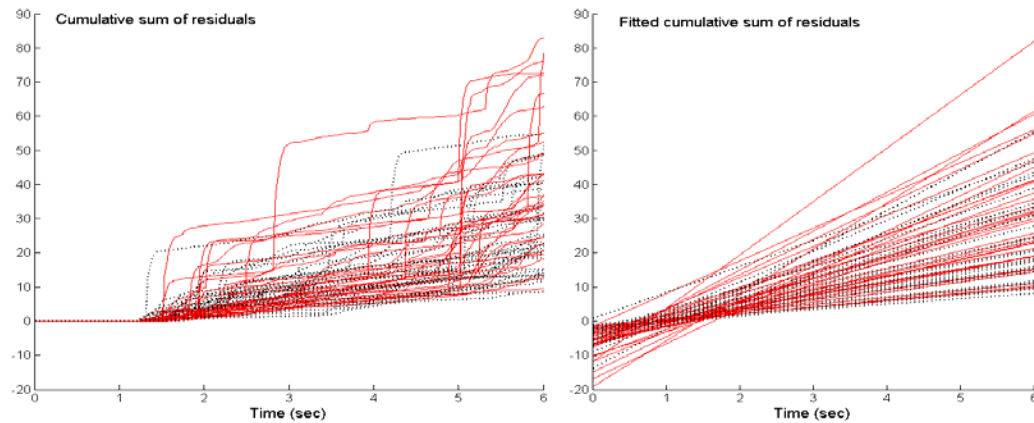

Figure 43. Cumulative sum of residuals for two groups of segments with (red line) and without (black dotted line) lane departures (left graph) and fitted with linear regression cumulative sum of residuals (right graph). For any value  $x$  on the horizontal axis on the left graph, the corresponding value on the vertical axis is the sum of the residuals associated with the values less than or equal to  $x$



Thus, based only on visual behavior, e.g., percent of off-road and on-road glances, it is not possible to predict poor lane-keeping performance associated with lane departures. Other aspects of driving behavior, e.g., task prioritization, and eye movements, e.g., ambient vision, should be taken into account. These differences are reflected to some degree in the eye-steering model. The model is sensitive to lane departures when considering the difference in residuals for two groups of segments with and without lane departure.

### Conclusion

This chapter examines the contribution of eye-steering correlation to *distracted condition – lane position* relationship. The correlation parameters might affect the magnitude of lane position changes associated with distraction (i.e., moderate changes) or might be considered as a mechanism that produces these changes (i.e., mediate changes). As a measure of eye-steering correlation, two parameters are considered – the correlation coefficient and time delay between eye and steering movements. This examination shows that (1) both correlation parameters do not moderate lane position changes; and (2) the correlation coefficient does not mediate the changes in lane position but time delay does.

The result that time delay, as a mediator, affects changes in lane keeping when a driver is distracted is important in terms of predicting vehicle state based on timing between visual input and steering output. The relative timing between eye and steering movements can be used as a prospective indicator of a vehicle position in the lane. This prediction could guide distraction mitigations that might reduce crash risk caused by large deviation from centerline. Because of vehicle dynamics, a driver can be alerted before or at an early stage of these changes. This mediation is partial, i.e. time delay only partially explains changes in lane position.

Thus, it is more likely that there are other mechanisms responsible for these changes; and future research should focus on examining them.

Because time delay between eye and steering movements is sensitive to distraction and affects lane-keeping performance, it was expected that an eye-steering model might be sensitive to lane departures as a result of a dangerously distracted condition. This hypothesis is tested for two groups of data from visual distraction condition: one group of segments includes lane departures and the other does not. The selected eye-steering model performance measured through *Best Fit* did not significantly differ for these two groups. However, the analysis of residuals (predicted minus measured output) revealed differences in model performance between two groups. The total sum of residuals' absolute values and trends of cumulative sum of residuals differentiated these two groups.

An assumption that lane departures are associated with longer off-road glances was not confirmed: the percent of off-road glances was not significantly different for these two groups. Thus, although visual behavior is the indicator of poor driver performance and is associated with lane departures, it is not sufficient to predict lane departures. There are factors responsible for breakdowns in vehicle control, e.g., safety margin preferences and task prioritization. Another reason is that eye movements are associated with focal vision, but not with ambient vision that is most likely responsible for lane keeping. All these assumptions require additional examination to investigate risky driving. The interesting result is that although model performance measured through *Best Fit* was not sensitive to lane departures, the cumulative sum of residuals differs when two groups of segments with and without lane departures were compared.

Overall, an eye-steering model defined for baseline condition can distinguish not only distracted condition associated with off-road glances but can

also predict breakdowns in lane keeping, i.e. lane departures. This model succeeds where simpler approaches based only on eye movement data fail.

## CHAPTER 6. CONCLUSIONS

Driver distraction contributes to crashes and fatalities. Rapidly developing in-vehicle technology and electronic devices could worsen situation and jeopardizes safety. Technology that can detect and mitigate distraction by alerting drivers could play a central role in maintaining safety.

Numerous attempts have been made in the development of distraction detection algorithms. These algorithms use visual or driver performance metrics to detect visual and cognitive distractions that have the highest impact on driver performance. Several distraction detection and mitigation systems are on the market or exist as advanced prototypes; and there is a growing interest from automakers regarding the design and implementation of such distraction detection systems. Correctly identifying driver distraction in real time is a critical challenge in distraction detection and mitigation; and this function has not been well developed. The benefit from these systems would be a prediction of dangerous situations associated with breakdowns in lane keeping control. This prediction can also reduce the number of false alarms. This dissertation contributes to the development of a new algorithm based on both visual behavior and driver performance to detect driver distraction and predict breakdowns in lane keeping.

The central hypothesis of this study is that it is possible to detect distraction by considering relationship between visual and steering behavior. Furthermore, the changes in eye-steering behavior should prospectively indicate vehicle position in the lane and predict breakdowns in vehicle control, i.e., lane departures.

The underlying assumption stems from strong eye-steering coordination observed on curvy roads where eye movements guide steering. Three different concepts were considered to explain this relationship: visual information framework, oculomotor controller concept, and intermittent control concept. It is

assumed that eye-steering relationship depends on the type of eye movements, e.g., eye movements guide steering, eyes scan road ahead, and eyes move away from the road scene. This study demonstrates the initial attempts to evaluate eye-steering correlation on a straight road with an assumption that it is a qualitatively and quantitatively different relationship compared with curvy roads. Eye movements associated with road scanning when there is no need for steering leads to a low correlation. However, even this weak eye-steering relationship could be sensitive to distraction.

To study the hypothesis, three specific aims were fulfilled. The first aim examined the effect of distracting activity on eye movements and steering wheel position to assess the degree to which the correlation parameters are indicative of distraction. The second aim used a control-theoretic approach of eye-steering system identification to distinguish between distracted and non-distracted conditions. The third aim examined whether changes in the eye-steering correlation associated with distraction provides a prospective indication of breakdowns in lane keeping, i.e., lane departures.

The first aim demonstrates that the eye-steering correlation parameters – correlation coefficient and time delay – are sensitive to distraction. Time delay is sensitive to all three types of distraction, i.e., visual, cognitive, and cognitive/visual. The correlation coefficient is mostly affected by off-road glances: visual and cognitive/visual distracted conditions cause its decrease. The cognitive/visual distraction has the strongest effect on correlation statistics: the correlation coefficient has the lowest and the time delay has the highest value among three distracted conditions. Based on correlation coefficient and time delay changes, it is possible to differentiate between not only distracted and non-distracted driving but also between the types of distraction: visual, cognitive, and cognitive/visual.

The second aim demonstrates efforts for eye-steering system identification to predict the current steering angle through its previous values and eye position. The eye-steering model derived for non-distracted condition shows sensitivity to off-road glances, i.e., visual and cognitive/visual distraction. The models derived for each driver have some similarity and each model fits to the data from other subjects reasonably well. In the meantime, some differences (e.g., time delay between input and output and the number of previous outputs that predict the current output) indicate the variability in driving behavior: some people have more complex driving behavior than others do. The attempt to select a single model that can successfully discriminate between distracted and non-distracted conditions for all the drivers was successful: the selected model effectively distinguishes visual and cognitive/visual distractions. Generalizing all the results, the model with the same structure and order can fit to the data equally well if the particular parameters fit to individual drivers. This model can predict distraction associated with off-road glances.

The third aim demonstrates that the time delay between eye and steering movements mediates changes in lane position. The hypothesis that eye-steering model could be sensitive to breakdowns in lane keeping, i.e. lane departures, was confirmed. This hypothesis was based on the assumption that lane departures are a result of a dangerously distracted condition associated with off-road glances. However, the percent of off-road glances calculated for two groups of segments with and without lane departures was not significantly different. Thus, although visual behavior is considered as a main indicator of distraction and poor driving performance, this outcome implies that it is not a sufficient indicator of breakdowns in vehicle control. Other factors contribute to these breakdowns. With this approach, the role of ambient vision in lane keeping should be considered as well. All these assumptions require additional examination to investigate

relationship between visual behavior and lane keeping. When model performance was used to predict lane departures, the *Best Fit* values did not significantly change when the instances with lane departures were compared to the instances without lane departures from the visually distracted condition. However, the analysis of residuals revealed the differences in the total sum and cumulative sum of residuals between these two groups.

All three aims indicate that (1) the eye-steering correlation parameters, i.e., correlation coefficient and time delay, can be considered as indicators of distraction; (2) the eye-steering model is sensitive to distraction associated with off-road glances; (3) time delay between eye and steering movement mediates changes in lane position; and (4) the model fit measured through the residuals are different for segments with lane departures compared with the segments without lane departures.

The limitation of this study is that the results are obtained from simulator driving and they cannot be generalized to driving on the full range of roads and traffic situations drivers face on a daily basis. Any driving simulator has a number of intrinsic limitations, i.e., restricted field of view (no rearview and side view mirrors), image resolution and presentation delay, and, the most important, driver perception of a safety.

The practical contribution of this dissertation will be toward design of the systems adaptive to driver state. These systems can provide a diagnostic measure of distraction in advance of mishaps. The development of a prospective indicator of diminished driver performance can be helpful in mitigating and preventing many impairment-related crashes. Based on the results of this study, a prospective indication of breakdowns in lane keeping could be based on visual behavior and vehicle control, i.e., correlation between eye and steering movements.

A crucial part of this prediction is the examination of factors that can affect this correlation. The future research should focus on studying different factors (e.g., driving environment, age, and experience) that can influence the eye-steering correlation. Another important direction of the future research is an examination of the changes in eye-steering correlation caused by off-road glances at different locations. This examination can distinguish between different degrees of distraction associated with the location of off-road glances indicating that some of them could be more dangerous than others. The vertical eye position could also be considered as an additional input into the model. The examination of eye-steering correlation in different driving environments provides evaluation and deeper understanding of visual-motor performance in driving.

This approach of visuomotor performance could also be applied to other domains, including robotic control, human-computer interaction (HCI), and medical diagnostic and rehabilitation.



## REFERENCES

- Ahlstrom, C., K. Kircher and A. Kircher (2009). Considerations when calculating percent road centre from eye movement data in driver distraction monitoring. Proceedings of the Fifth International Driving Symposium on Human Factors in Driver Assessment, Training and Vehicle Design, Big Sky, Montana.
- Angell, L. S., J. Auflick, P. A. Austria, D. Kochar, L. Tijerina, W. J. Biever, T. Diptiman, J. Hogsett and S. Kiger (2006). Driver Workload Metrics Task 2 Final Report. Washington, DC, National Highway Traffic Safety Administration.
- Baron, R. M. and D. A. Kenny (1986). "The moderator-mediator variable distinction in social psychological research: Conceptual, strategic and statistical considerations." *Journal of Personal and Social Psychology* 51(6): 1173-1182.
- Beauchamp, K. G. (1973). Signal processing Using analog and Digital Technique. London, George allen and Unwin Ltd.
- Becka, T. W., T. J. Housha, J. P. Weir, J. T. Cramer, V. Vardaxis, G. O. Johnson, J. W. Coburn, M. H. Malek and M. Mielkea (2006). "An examination of the Runs Test, Reverse Arrangements Test, and modified Reverse Arrangements Test for assessing surface EMG signal stationarity." *Journal of Neuroscience Methods* 156: 242-248.
- Bendat, J. S. and A. G. Piersol (1986). Random data. Analysis and measurement procedures. John Wiley & Sons, Inc.
- Bennett, J. A. (2000). "Mediator and moderator variables in nursing research: conceptual and statistical differences." *Research in Nursing and Health* 23: 415-420.
- Carsten, O., N. Merat, W. H. Janssen, E. Johansson, M. Fowkes and K. A. Brookhuis (2005). HASTE Final report, E.U. European Commission.
- Castiglioni, P. and M. Di Rienzo (2004). "How to check steady-state condition from cardiovascular time series." *Physiological Measurement* 25: 985-996.
- Chambers, J., W. Cleveland, B. Kleiner and P. Tukey (1983). Graphical Methods for Data Analysis, Wadsworth.
- Charlton, S. G. (2009). "Driving while conversing: Cell phones that distract and passengers who react." *Accident Analysis and Prevention* 41(1): 160-173.
- Chattington, M., M. Wilson, D. Ashford and D. E. Marple-Horvat (2007). "Eye-steering coordination in natural driving." *Experimental Brain Research* 180: 1-14.
- Chen, L. and A. G. Ulsoy (2001). "Identification of a driver steering model, and model uncertainty, from driving simulator data." *Journal of Dynamic Systems, Measurement, and Control* 123: 623-629.

- Cooper, P. J. and Y. Zheng (2002). "Turning gap acceptance decision-making: the impact of driver distraction." *Journal of Safety Research* 33(3): 321-335.
- Dingus, T. A., S. G. Klauer, V. L. Neale, A. Petersen, S. E. Lee, J. Sudweeks, M. A. Perez, J. Hankey, D. Ramsey, S. Gupta, C. Bucher, Z. R. Doerzaph, J. Jermeland and R. R. Knipling (2006). *The 100-Car Naturalistic Driving Study, Phase II – Results of the 100-Car Field Experiment*. Blacksburg, Virginia, Virginia Tech Transportation Institute.
- Donges, E. (1978). "A two-level model of driver steering behavior." *Human Factors* 20(6): 691-707.
- Donmez, B., L. N. Boyle and J. D. Lee (2006). "Drivers' attitudes toward imperfect distraction mitigation strategies." *Transportation Research Part F: Traffic Psychology* 9(6): 387-398.
- Donmez, B., L. N. Boyle and J. D. Lee (2006). "The impact of driver distraction mitigation strategies on driving performance." *Human Factors* 48(4): 785-804.
- Donmez, B., L. N. Boyle and J. D. Lee (2007). "Safety implications of providing real-time feedback to distracted drivers." *Accident Analysis & Prevention* 39(3): 581-590.
- Donmez, B., L. N. Boyle and J. D. Lee (2008). *Designing feedback to mitigate distraction*. *Driver Distraction: Theory, Effects, and Mitigation*. M. A. Regan, J. D. Lee and K. L. Young, CRC Press: 519-531.
- Donmez, B., L. N. Boyle and J. D. Lee (2008). "Mitigating driver distraction with retrospective and concurrent feedback " *Accident Analysis & Prevention* 40: 776-786
- Donmez, B., L. N. Boyle, J. D. Lee and G. Scott (2006). *Assessing differences in young drivers' engagement in distractions*. The Transportation Research Board 85th Annual Meeting, Washington DC.
- Elliott, D. (1992). *Intermittent versus continuous control of manual aiming movements*. *Vision and Motor Control*. L. Proteau and D. Elliott. Amsterdam, Elsevier: 33-48.
- Engstrom, J., E. Johansson and J. Ostlund (2005). "Effects of visual and cognitive load in real and simulated motorway driving." *Transportation Research Part F-Traffic Psychology and Behaviour* 8(2): 97-120.
- Engström, J. and S. Mårdh (2007). *SafeTE final report*, Vägverket.
- Engström, J. and T. W. Victor (2008). *Real-time distraction countermeasures*. *Driver Distraction: Theory, Effects, and Mitigation*. M. A. Regan, J. D. Lee and K. L. Young, CRC Press.
- FARS. (2008). "Fatality Analysis Reporting System Encyclopedia." September, 2009, from <http://www-fars.nhtsa.dot.gov/Main/index.aspx>.

- Gottman, J. M. (1981). *Time-series analysis: a comprehensive introduction for social scientists*. Cambridge, New York, Cambridge University Press.
- Harbluk, J. L., Y. I. Noy and M. Eizenman (2002). *The impact of cognitive distraction on driver visual behaviour and vehicle control*. Canada, Ergonomics Division, Road safety Directorate and Motor Vehicle Regulation Directorate, Transport Canada.
- Harbluk, J. L., Y. I. Noy, P. L. Trbovich and M. Eizenman (2007). "An on-road assessment of cognitive distraction: Impacts on drivers' visual behavior and braking performance." *Accident Analysis and Prevention* 39: 372–379.
- Hartmann, D. P., J. M. Gottman, R. R. Jones, W. Gardner, A. E. Kazdin and R. S. Vaught (1980). "Interrupted time-series analysis and its application to behavioural data." *Journal of applied behavior analysis* 13(4): 543-559.
- Hildreth, E. C., J. M. H. Beusmans, E. R. Boer and C. S. Royden (2000). "From vision to action: Experiments and models of steering control during driving." *Journal of Experimental Psychology: Human Perception and Performance* 26(3): 1106-1132.
- Hoedemaeker, M. and M. A. Neerinx (2007). *Attuning In-Car User Interfaces to the Momentary Cognitive Load*. *Augmented Cognition*. HCHI 2007 and FAC 2007. D. D. Schmorow and L. M. Reeves. Berlin Heidelberg, Springer-Verlag 4565: 286–293.
- Hollands, M. A., N. V. Zivara and A. M. Bronstein (2004). "A new paradigm to investigate the roles of head and eye movements in the coordination of whole-body movements." *Experimental Brain Research* 154: 261–266.
- Horberry, T., J. Anderson, M. A. Regan, T. J. Triggs and J. Brown (2006). "Driver distraction: The effects of concurrent in-vehicle tasks, road environment complexity and age on driving performance." *Accident Analysis and Prevention* 38(1): 185-191.
- Horrey, W. J., M. F. Lesch and A. Garabet (2008). "Assessing the awareness of performance decrements in distracted drivers." *Accident Analysis & Prevention* 40(2): 675-682.
- Horrey, W. J. and C. D. Wickens (2004). "Driving and side task performance: The effects of display clutter, separation, and modality." *Human Factors* 46(4): 611-624.
- Horrey, W. J. and C. D. Wickens (2006). "Examining the impact of cell phone conversations on driving using meta-analytic techniques." *Human Factors* 48(1): 196- 205.
- Horrey, W. J., C. D. Wickens and K. P. Consalus (2006). "Modeling drivers' visual attention allocation while interacting with in-vehicle technologies." *Journal of Experimental Psychology-Applied* 12(2): 67-78.
- Juang, J. (1994). *Applied System Identification*. Englewood Cliffs, New Jersey, PTR Prentice Hall Inc. .

- Judd, C. M., D. A. Kenny and G. H. McClelland (2001). "Estimating and testing mediation and moderation in within-subject designs." *Psychological Methods* 6(2): 115-134.
- Kircher, K., A. Kircher and F. Claezon (2009). *Distraction and drowsiness - field study*. Sweden, VTI rapport 638A.
- Klauer, S. G., T. A. Dingus, V. L. Neale, J. D. Sudweeks and D. J. Ramsey (2006). *The impact of driver inattention on near-crash/crash risk: An analysis using the 100-car naturalistic driving study data*. Washington, DC, National Highway Traffic Safety Administration.
- Kutilla, M. H., M. Jokela, T. Mäkinen, J. Viitanen, G. Markkula and T. W. Victor (2007). "Driver cognitive distraction detection: Feature estimation and implementation " *Proceedings of the Institution of Mechanical Engineers, Part D: Journal of Automobile Engineering* 221(9): 1027-1040.
- Land, M. F. (1993). *Eye-head coordination during driving*. IEEE Systems, Man and Cybernetics Conference Proceedings.
- Land, M. F. (2006). "Eye movements and the control of actions in everyday life." *Progress in Retinal and Eye Research* 25(3): 296-324.
- Land, M. F. (2009). "Vision, eye movements, and natural behavior." *Visual Neuroscience* 26: 51-62.
- Land, M. F. and S. Furneaux (1997). "The knowledge base of the oculomotor system." *Philosophical Transactions of the Royal Society of London, Series B* 352: 1231-1239.
- Land, M. F. and J. Horwood (1995). "Which parts of the road guide steering." *Nature* 377(6547): 339-340.
- Land, M. F. and D. N. Lee (1994). "Where we look when we steer." *Nature*(369): 742-744.
- Land, M. F., N. Mennie and J. Rusted (1999). "The roles of vision and eye movements in the control of activities of daily living." *Perception* 28(11): 1311-1328.
- Land, M. F. and B. W. Tatler (2001). "Steering with the head: The visual strategy of a racing driver." *Current Biology* 11(15): 1215-1220.
- Lansdown, T., N. Brook-Carter and T. Kersloot (2004). "Distraction from multiple in-vehicle secondary tasks: vehicle performance and mental workload implications." *Ergonomics* 47(1): 91-104.
- Lee, J. D., K. L. Young and M. A. Regan (2008). *Defining driver distraction. Driver Distraction: Theory, Effects, and Mitigation*. M. A. Regan, J. D. Lee and K. L. Young. Boca Raton, FL, CRC Press: 31-40.
- Lesch, M. F. and P. A. Hancock (2004). "Driving performance during concurrent cell-phone use: are drivers aware of their performance decrements?" *Accident Analysis and Prevention* 36(3): 471-480.

- Liang, Y. (2009). Detecting Driver Distraction. Iowa City, The University of Iowa. Doctoral Thesis.
- Liang, Y., J. D. Lee and M. L. Reyes (2007). "Non-intrusive detection of driver cognitive distraction in real-time using Bayesian networks." *Transportation Research Board*(2018): 1-8.
- Liang, Y., M. L. Reyes and J. D. Lee (2007). "Real-time detection of driver cognitive distraction using Support Vector Machines." *IEEE Intelligent Transportation Systems* 8(2): 340-350.
- Lin, D. Y., L. J. Wei and Z. Ying (2002). "Model-checking techniques based on cumulative residuals." *Biometrics* 58: 1-12.
- Ljung, L. (1987). *System Identification: Theory for the User*. Englewood Cliffs, New Jersey, Prentice-Hall, Inc.
- Ljung, L. (1995). *System Identification Toolbox. User's Guide*, The MathWorks, Inc.
- Ljung, L. (2009). "System Identification Toolbox™ 7 user's Guide." The MathWorks, Inc.
- Maronna, R. A., R. D. Martin and V. J. Yohai (2006). *Robust Statistics – Theory and Methods*. Chichester, England, John Wiley & Sons, Ltd
- Marple-Horvat, D. E., M. Chattington, M. Anglesea, D. G. Ashford, M. Wilson and D. Keil (2005). "Prevention of coordinated eye movements and steering impairs driving performance." *Experimental Brain Research* 163: 411–420.
- Marple-Horvat, D. E., H. L. Cooper, S. L. Gilbey, J. C. Watson, N. Mehta, D. Kaur-Mann, M. Wilson and D. Keil (2008). "Alcohol badly affects eye movements linked to steering, providing for automatic in-car detection of drink driving." *Neuropsychopharmacology* 33: 849 – 858.
- McCain, L. J. and R. T. McCleary (1979). *The statistical analysis of the simple interrupted time-series quasiexperiment. Quasi-experimentation: Design & analysis issues for field settings*. T. D. Cook and D. T. Campbell. Chicago, Rand McNally.
- McRuer, D. T., R. W. Allen, D. H. Weir and R. H. Klein (1977). "New results in driver steering control models." *Human Factors* 19: 381-397.
- Miall, R. C. and G. Z. Reckess (2002). "The cerebellum and the timing of coordinated eye and hand tracking." *Brain and Cognition* 48: 212-226.
- Miall, R. C., D. J. Weir and J. F. Stein (1988). "Planning of movement parameters in a visuo-motor tracking task." *Behavioural Brain Research* 27: 1-8.
- Nakayama, O., T. Futami, T. Nakamura and E. R. Boer (1999). "SAE Technical Paper Series: Development of a steering entropy method for evaluating driver workload." *Human Factors in Audio Interior Systems, Driving, and Vehicle Seating SP-1426*.

- NHTSA (2010). Distracted Driving 2009. Traffic Safety Facts. Research Note, NHTSA's National Center for Statistics and Analysis.
- Östlund, J., L. Nilsson, J. Torson and A. Forsman (2006). Effects of cognitive and visual load in real and simulated driving VTI publication. Sweden VTI.
- Östlund, J., L. Nilsson, O. Carsten, N. Merat, H. Jamson, S. Jamson, S. Mouta, J. Carvalhais, J. Santos, V. Anttila, H. Sandberg, J. Luoma, D. de Waard, K. Brookhuis, E. Johansson, J. Engström, T. W. Victor, J. Harbluk, W. Janssen and R. Brouwer. (2004). "HASTE Deliverable 2. HMI and Safety-Related Driver Performance." Retrieved March, 2009.
- Östlund, J., B. Peters, B. Thorslund, J. Engström, G. Markkula, A. Keinath, D. Horst, S. Juch, S. Mattes and U. Foehl. (2006). "Deliverable 2.2.5 - Driving performance assessment - methods and metrics." No. IST-1-507674-IP. from [http://www.aide-eu.org/pdf/sp2\\_deliv\\_new/aide\\_d2\\_2\\_5.pdf](http://www.aide-eu.org/pdf/sp2_deliv_new/aide_d2_2_5.pdf).
- Parasuraman, R., P. A. Hancock and O. Olofinboba (1997). "Alarm effectiveness in driver-centred collision-warning systems." *Ergonomics* 40(3): 390-399.
- Patten, C. J. D., A. Kircher, J. Ostlund and L. Nilsson (2004). "Using mobile telephones: cognitive workload and attention resource allocation." *Accident Analysis and Prevention* 36(3): 341-350.
- Pilutti, T. and A. G. Ulsoy (1999). "Identification of driver state for lane-keeping tasks." *IEEE Transactions on systems, man, and cybernetics: Part A: Systems and humans* 29(5): 486-502.
- Pohl, J., W. Birk and L. Westervall (2007). "A driver-distraction-based lane-keeping assistance system." *Proceedings of the IMECH E Part I Journal of Systems & Control Engineering* 221(4): 541-552.
- Poysti, L., S. Rajalin and H. Summala (2005). "Factors influencing the use of cellular (mobile) phone during driving and hazards while using it." *Accident Analysis and Prevention* 37(1): 47-51.
- Preacher, K. J. and A. F. Hayes (2004). "SPSS and SAS procedures for estimating indirect effects in simple mediation models." *Behavior Research Methods, Instruments, & Computers* 36(4): 717-731.
- Rakauskas, M. E., L. J. Gugerty and N. J. Ward (2004). "Effects of naturalistic cell phone conversations on driving performance." *Journal of Safety Research* 35(4): 453-464.
- Recarte, M. A. and L. M. Nunes (2000). "Effects of verbal and spatial-imagery tasks on eye fixations while driving." *Journal of Experimental Psychology: Applied* 6(1): 31-43.
- Recarte, M. A. and L. M. Nunes (2003). "Mental workload while driving: Effects on visual search, discrimination, and decision making." *Journal of Experimental Psychology: Applied* 9(2): 119-137.
- Regan, M. A., J. D. Lee and K. L. Young (2008). *Driver Distraction: Theory, Effects and Mitigation*. Boca Raton, Florida, CRC Press.

- Reyes, M. L. and J. D. Lee (2008). "Effects of cognitive load presence and duration on driver eye movements and event detection performance." *Transportation Research Part F: Traffic Psychology*: 391-402.
- Roy, R., P. Micheau and P. Bourassa (2009). "Intermittent predictive steering control as an automobile driver model." *Journal of Dynamic Systems, Measurement, and Control* 131(1): 014501-014506.
- SafetyNet (2009) "Vehicle Safety."
- Salvucci, D. D. (2006). "Modeling driver behavior in a cognitive architecture." *Human Factors* 48(2): 362–380.
- Salvucci, D. D. and J. H. Goldberg (2000). *Identifying Fixations and Saccades in Eye-Tracking Protocols*. Proceedings of the Eye Tracking Research and Applications Symposium, ACM Press.
- Salvucci, D. D. and R. Gray (2004). "A two-point visual control model of steering." *Perception* 33: 1233-1248.
- Sayer, J. R., M. L. Mefford and J. L. Shirkey (2005). "Driver distraction: A naturalistic observation of secondary behaviors with the use of driver assistance systems." *Proceedings of the Third International Driving Symposium on Human Factors in Driver Assessment, Training and Vehicle Design*: 255-261.
- Siegel, S. and J. N. J. Castellan (1988). *Nonparametric statistics for the behavioral sciences*. New York, McGraw-Hill.
- Smiley, A., L. Reid and M. Fraser (1980). "Changes in driver steering control with learning." *Human Factors* 22(4): 401-415.
- Stein, J. F. and M. Glickstein (1992). "Role of the cerebellum in visual guidance of movement." *Physiological Reviews* 72(4): 967–1017.
- Strayer, D. L., F. A. Drews and W. A. Johnston (2003). "Cell phone-induced failures of visual attention during simulated driving." *Journal of Experimental Psychology-Applied* 9(1): 23-32.
- Strayer, D. L. and W. A. Johnston (2001). "Driven to distraction: Dual-task studies of simulated driving and conversing on a cellular telephone." *Psychological Science* 12(6): 462-466.
- Stutts, J. and W. Hunter (2003). "Driver inattention, driver distraction and traffic crashes." *ITE Journal* 73(7): 34-36, 43-45.
- TSAR. (2008). "Transportation Statistics Annual Report (TSAR)." Retrieved March 08, 2010, from [http://www.bts.gov/publications/transportation\\_statistics\\_annual\\_report/2008/](http://www.bts.gov/publications/transportation_statistics_annual_report/2008/).
- Victor, T. W. (2005). *Keeping eye and mind on the road*. Uppsala, Sweden, Uppsala University. Unpublished Doctoral Thesis.

- Victor, T. W., J. L. Harbluk and J. A. Engstrom (2005). "Sensitivity of eye-movement measures to in-vehicle task difficulty." *Transportation Research Part F* 8: 167-190.
- Wagner, A. K., S. B. Soumerai, F. Zhang and D. Ross-Degnan (2002). "Segmented regression analysis of interrupted time series studies in medication use research." *Journal of Clinical Pharmacy and Therapeutics* 27: 299–309.
- Wickens, C. D. (2002). "Multiple resources and performance prediction." *Theoretical Issues in Ergonomics Science* 3(2): 159-177.
- Wilson, M., M. Chattington and D. E. Marple-Horvat (2008). "Eye movements drive steering: reduced eye movement distribution impairs steering and driving performance." *Journal of Motor Behavior* 40(3): 190–202.
- Wilson, M., S. Stephenson, M. Chattington and D. E. Marple-Horvat (2007). "Eye movements coordinated with steering benefit performance even when vision is denied." *Experimental Brain Research* 176: 397–412.
- Young, K. and M. Regan (2007). *Driver distraction: A review of the literature. Distracted driving*. I. J. Faulks, M. Regan, M. Stevenson et al. Sydney NSW: Australasian College of Road Safety: 379-405.
- Zhang, H., M. R. H. Smith and G. J. Witt (2006). "Identification of real-time diagnostic measures of visual distraction with an automatic eye-tracking system " *Human Factors* 48(4): 805-821.
- Zhang, Y., Y. Owechko and J. Zhang. (2004). *Driver cognitive workload estimation: a data-driven perspective*. IEEE Intelligent Transportation Systems Conference. Washington, D.C., IEEE.